





Our Brochure is available through Easyquote software making quoting & ordering easier.



The largest selection of designer radiators and towel rails to suit any home interior.

## Design

---

- Over 52 exclusive and affordable designs.
- Italian design & manufacture.
- Efficient low water content designs saving energy and reducing running costs.

## Choice

---

- UK's largest brochure selection of radiators and towel rails.
- Over 1250 sizes and colours are available from stock, delivered in 48-72 hours.
- Thousands of Made to Order options in over 200 colours and special finishes.
- Sectional Specialists in Steel Multi Column, Aluminium and Cast Iron.

## Service

---

- A dedicated UK Customer Service Team to make your purchase as smooth as possible.
- Order from our network of Plumbing & Heating Merchants including over 500 Showrooms nationwide.
- Free Delivery on all radiators and towel rails to UK mainland Showrooms and Merchants.
- Minimum 10-Year Guarantee on all radiators and towel rails.
- All radiators and towel rails are CE/UKCA approved and certified to BS EN442.



---

The Radiator Company is a brand of **IRSAP**, Italy's leading manufacturer of design led radiators.



# Radiators

## Steel Multi Column pages 6-29 / 128-149

	Product	Technical
Ancona® Stock	8-17	128-137
Ancona® Made to Order	18-25	138-143
Ancona® Bench Seat	26-27	144-145
Ancona® Curved	28	146
Ancona® Electric	29	147

## Contemporary Designer pages 30-61 / 148-173

	Product	Technical
Ceramica Collection	32-33	148
Torré	34-35	149
Niro	36-37	150
Iseo	38-39	151
Sebino	40-41	152
Odolo	42-43	153
Canto	44	154
Ellipsis Stainless Steel	45	155
Ellipsis	46-47	156-159
Sitar48-49	160-163	
Sax	50-51	164-165
Piano	52-53	166-167
Water Lily	54	168
Immagina	55	169
Athena	56-57	170
Relax	58-59	172-173
Halo	60-61	171

## Sectional Aluminium pages 62-71 / 174-183

	Product	Technical
Vip	64-65	176-177
Oscar	66-67	178-179
Vox	68-69	180-181
Mix	70-71	182-183

## Traditional Cast Iron pages 72-87 / 184-194

	Product	Technical
Ledbury	74-75	186-187
Aston	76-77	185
Stamford	78-79	192
Telford	80-81	188-189
Linton	82-83	190-191
Trieste	84-85	193
Bohemia	86-87	194

## Towel Rails pages 88-115 / 195-213

	Product	Technical
Step BDO	90	196
Step	91	197
Athena BDO	92	195
Athena Towel Rail	93	195
Relax Bagno	94	198
Echo	95	199
Piano Towel Rail	96	200
Piano Lato	97	199
Quadre	98	201
Griffin	99	202
Pulsar	100	203
Ellipsis Towel Rail	101	204
Sitar Lato	102	205
Sitar BDO	103	205
Poll BDO	104	206
Poll	105	207
Poppy	106-107	208
Lupin	108-109	209
Iris	110-111	210
Blues	112	203
Chalfont Range	113	212-213
Lingfield	114	211
Linton Towel Rail	115	211

## Valves & Accessories pages 116-127

Heating Elements	116-117
Valves	118-125
Accessories	126-127

### Technical Details & Prices pages 130-213

For details of our convector range (Trench & Mini), full Terms & Conditions and to find your local showroom or merchant: **01342 302250** or visit **theradiatorcompany.co.uk** where you will also find helpful tools such as our **heat output (BTU) calculator** as well as our **curved** and **sectional radiator builder**.

### Helpful Advice & How to Buy pages 214-219

### RAL Colours & Colour Co-ordination pages 216-217

### Index page 218





# Ancona® - Steel Multi Column

Italy, has earned an outstanding worldwide reputation for being at the leading edge of radiator design, style and practical functionality. Produced in our factory in Italy the Ancona® range of Steel Multi Column radiators take the classic look of cast iron and combines it with the flexibility of steel; suitable for all interiors. Multiple column depths, heights and widths provide an extensive choice of sizes and outputs to suit any room or location.

**Stock** pages 10-17



Our stylish and timeless stock Ancona® Steel Multi Column is held in our UK warehouse for fast delivery. The most popular 2, 3 or 4 column sizes in 5 height options and 3 mounting options are available from stock;

- White RAL 9016 delivered in 48-72 hours
- Bare Metal Lacquer delivered in 48-72 hours + 3 new finishes delivered in up to 3 weeks
-  Feature Finishes: Copper, Textured Anthracite, Pearl Bronze, plus 3 new for this edition; Vintage green, Aged Brass and Satin Gold all delivered in up to 3 weeks
-  Colour Coordination service, price and lead time on application **see page 217**

We list all possible combinations on pages 130-137 in the technical section.



## Made To Order pages 18-25

The perfect solution, made to order in our Italian factory to fit your requirements.

We offer a vast range of sizes of Ancona Multi Column in 2-6 column options; with 3 different mounting options wall-hung, cast feet or welded feet. Added to this we have over 188 RAL colours plus 31 special finishes including Bare Metal Lacquer.

Combine all these choices and you have over 3 million combinations of sizes, colours and mounting options. To help make selection easier please use our online radiator builder, a simple way to select the best size, options and heat requirements for your space.



® Ancona is a registered trademark of IRSAP UK Limited.

# Ancona® - Finishes & Options

## Ancona® Bare Metal Lacquer finishes pages 16-17

This industrial bare metal finish is hand finished so every radiator is unique. Variations in colour, welding and burnishing marks differ from one section to another and add to the idiosyncrasy of each radiator. Sections are given a clear gloss lacquer protecting the bare metal and enhancing their individuality.

New for this edition we can apply a tinted lacquer top coat to give extra design options. See pages 136-137 for full details.



## Feature Finishes pages 14-17

Painted in the UK, these 3 new Feature Finishes give a personal touch to any room. They join our existing range, giving 6 exciting options to choose from. Vintage Green, Satin Gold and Aged Brass sit alongside Textured Anthracite, Copper and Pearl Bronze. See pages 130-135 for full details.

## Ancona® Bench Seat pages 30-31

A practical solution providing both seating and heating, perfect for boot rooms, utility rooms and conservatories. The Ancona bench seat comes supplied with a solid wooden top. See pages 144-145 for full range of sizes.



## Ancona® Curved page 28

Fitting a curved Ancona into your bay window or around a curved wall will give a truly bespoke finish to a room. All come with welded feet as standard & are available in 188 RAL colours & 30 special finishes. Use our [curved radiator builder online](#) or download the easy to follow Specification Instructions on our website [theradiatorcompany.co.uk](http://theradiatorcompany.co.uk).

## Ancona® Electric page 29

Our range of fully electric Ancona sizes provide the option to place your radiator in spaces where it is not possible or convenient to connect to the normal heating system. Available in one height (600mm) there are 7 sizes available with 3 sizes now available from stock. These radiators are filled with an oil/glycol mix and are IP24 rated. See page 147 for full range of sizes.



® Ancona is a registered trademark of IRSAP UK Limited.

# Ancona® - Stock

Ancona® stock radiators are incredibly versatile with literally hundreds of possible sizes in 2, 3 or 4 columns from 3-40 sections, in a choice of 3 mounting options (slip on welded feet, cast feet or 2 types of wall brackets) all available from stock.

Please visit our sectional radiator builder online [theradiatorcompany.co.uk](http://theradiatorcompany.co.uk).

## Design

Ancona® from stock, our stylish & timeless Ancona® Steel Multi Column is held in our UK warehouse for fast delivery.

- White RAL 9016 delivered in 48-72 hours
- New** Bare Metal Lacquer delivered in 48-72 hours, 2 tinted lacquers delivered in up to 3 weeks **see pages 136-137**
- New** Feature Finishes; Copper, Pearl Bronze, Textured Anthracite, Vintage Green, Satin Gold and Aged Brass delivered in up to 3 weeks
- 2, 3 & 4 column options
- 5 heights; 300mm, 500mm, 600mm, 750mm & 1800mm
- 3 mounting options; Slip-on Welded Feet, Wall Brackets & Cast Feet
- Up to 40 pre-assembled sections, nipple & gasket joined
- 10-year guarantee

See our full Stocked range of over 360 sizes on pages 128-137.

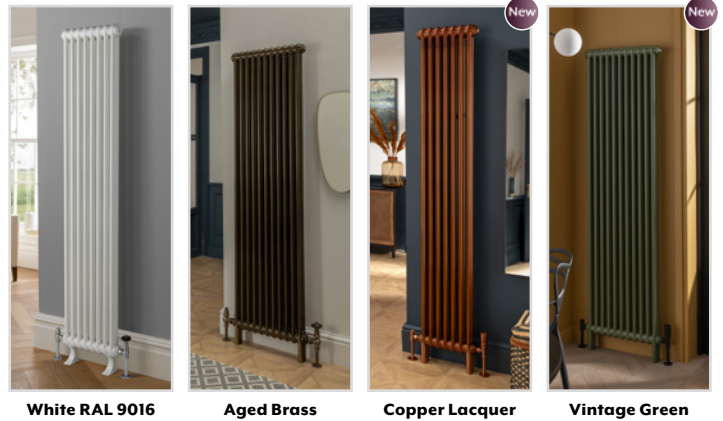

## Choice

### Columns

Ancona® stock radiators can be specified in either 2, 3 or 4 column depths in over 360 sizes in up to 40 sections.

### Mounting Options

Ancona® stock (excluding lacquer) can be mounted in one of 3 ways;

- Slip-on Welded Feet; for a contemporary look
- Cast Feet; for a classic look
- Wall Brackets to position your steel multi column at any height

Stock Bare Metal Lacquer radiators can be wall or floor mounted with universal brackets or slip on welded feet. **See pages 136-137 for more information.**

### Ancona® Towel Bars & Pegs

Made from steel and chromed, Ancona® towel bars can be added to Ancona® radiators to provide useful hanging space in kitchens or bathrooms. **Available from stock in 48-72 hours see page 127.**

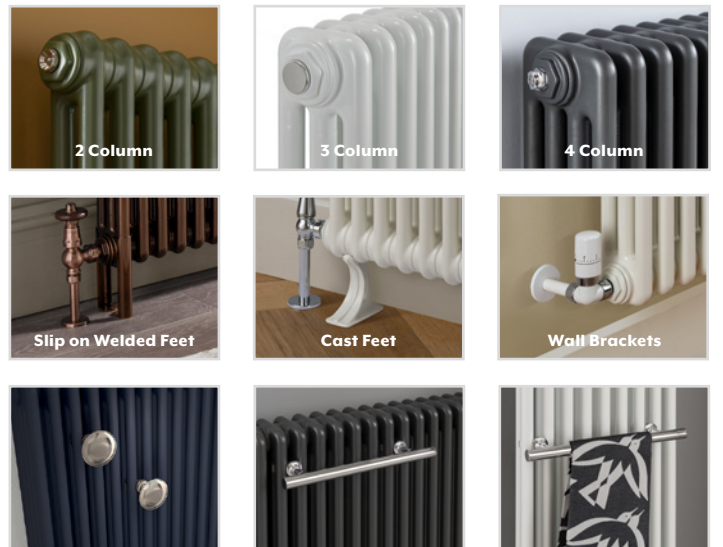

## Service

All Ancona® stock white and bare metal lacquer models are delivered in 48-72 hours. Feature Finishes: Copper, Pearl Bronze, Textured Anthracite, Vintage Green, Satin Gold and Aged Brass are available in up to 3 weeks.



### New Colour Coordination Service

please see page 217 for full details and how to order.

**SAVE £45\***

WITH OUR VALVE & PIPE COVERS PROMOTION, SEE PRODUCT PAGES AT THE BACK OF THE BROCHURE FOR FULL DETAILS. Go to our website [theradiatorcompany.co.uk](http://theradiatorcompany.co.uk).

Vintage TRV & Pipe Covers



Choose from our full list of Ancona® sizes on **pages 128-137** or by using our online radiator builder to select the best solution for your room. It will take you through the process quickly and easily and allows you to save your ideas to your own Wish List.

\*Saving based on the value of individual items when bought separately. Order any of our selected valves and matching pipe covers at the same time as your radiator.  
®Ancona is a registered trademark of IRSAP UK Limited.



# Ancona<sup>®</sup> 2 Column

Stocked White



Colour Coordinating service

Cast Feet, 1800mm x 386mm with Chrome Vintage TRVs.

# Ancona<sup>®</sup> 3 Column

Stocked White

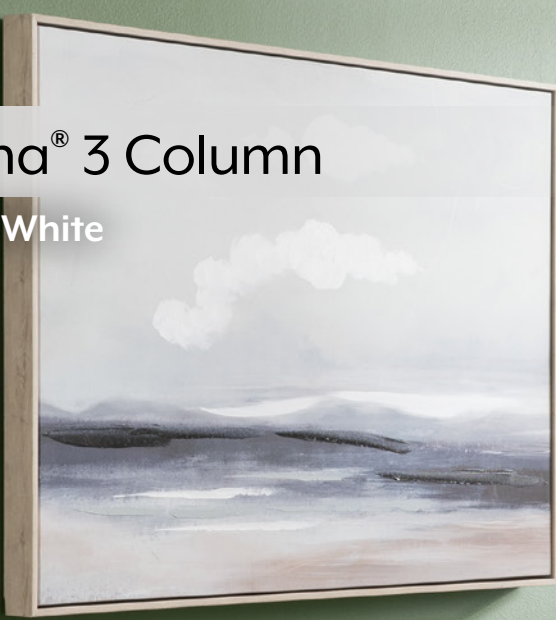

Wall Brackets, 500mm x 836mm with Chrome Corner Ideal TRVs.

# Ancona® 4 Column

Stocked White



Vintage Green

Slip on Welded Feet, 750mm x 836mm with White Ideal TRVs.

# Ancona® Textured Anthracite

## Feature Finishes



Copper

Textured Anthracite finish with Wall Brackets, 4 column, 600mm x 1196mm with Nickel Vintage TRVs.

# Ancona® Vintage Green

Feature Finishes

New



Aged Brass

Vintage Green finish with slip on feet, 2 column, 1800mm x 519mm with black Ideal TRVs.

# Feature Finishes

New

An exclusive collection of exciting and trending colours.

Our range of Feature Finishes is painted here in the UK and to complement our existing choices we are introducing three new colours for 2023. Please call 01342 302250 for sample swatches.



## Vintage Green

A warm, deep pastel, shade of green. Reminiscent of the arts and crafts movement and Edwardian era, Vintage Green is a calming and relaxed tone.



## Aged Brass

Bringing a luxurious touch to any room. Aged Brass has a sheen that highlights the depth of colour.



## Satin Gold

Warm and deep, Satin Gold has a silky tactile finish, a perfect complement to the soft tones of many bathroom and kitchen taps and accessories.



Copper



Textured Anthracite



Pearl Bronze

**Alongside the original colours of Copper, Textured Anthracite and Pearl Bronze, these new Feature Finishes give a personal touch to any room.**

Originally only available on our stock white Ancona models we have now extended them to all Sectional Aluminium and selected Cast Iron designs, as well as the Poppy and Lupin Towel rails.

These colours are top of the range, nuanced and striking. Painted in the UK they are usually delivered in 15 working days (slightly longer for 10 or more radiators or for deliveries to off shore islands and furthest reaches of the Mainland).



Lupin in Satin Gold

# Tinted Lacquers

New

Our Bare metal range shows off the raw industrial features created in the making of our Ancona range.

**The unique appearance of the sanding and welding marks combined with the base steel colour has become a firm favourite, delivering industrial Chic look. Now you can add another level of design to these individual products with our new tinted lacquers, Brass and Copper.**

As with the base bare metal version each radiator will be unique with distinctive marks and variable tones inherent with the raw manufacturing style of the products.

Each application of tinted lacquer will adhere differently across the different column options, for example on the deeper 4 column options where the internal areas may have a textured and more variable coating.

New Brass and Copper lacquer tints are finished in the UK and are delivered in 15 working days, [see page 136-137 for full details and prices.](#)

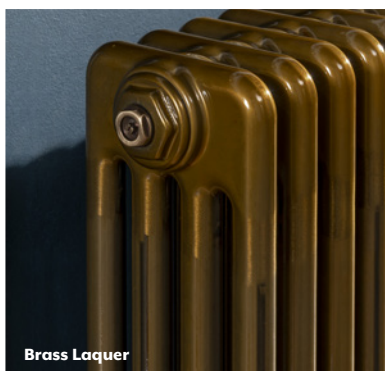

Brass Lacquer

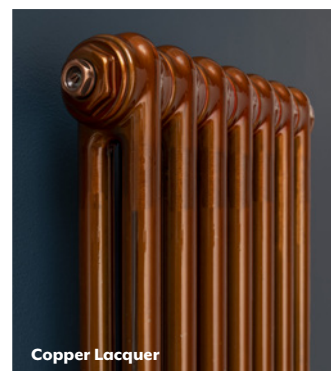

Copper Lacquer



Aged Brass Lacquer

# Ancona<sup>®</sup> 3 Column

Stocked Laquer

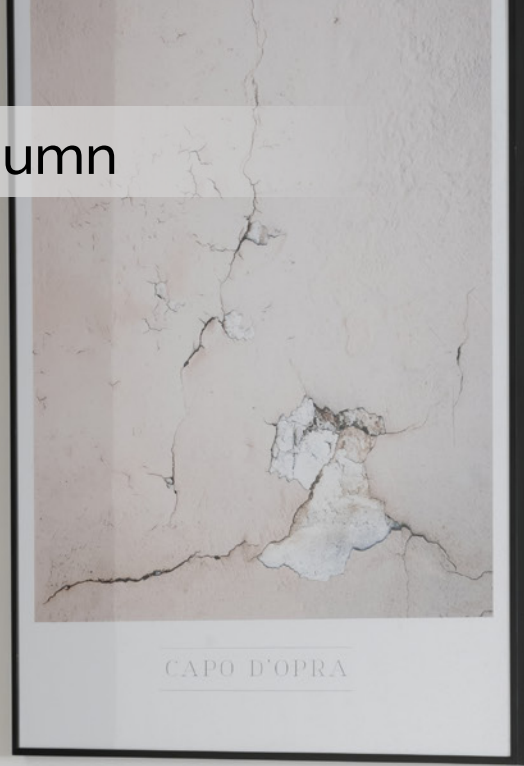

With Slip on Welded Feet, 600mm x 926mm with Nickel Vintage XL TRVs.





# Ancona<sup>®</sup> 2 Column

Copper Laquer



New

Brass Laquer

With Slip on Welded Feet, 1800mm x 341mm with Antique Copper Ideal TRVs.

# Ancona® - Made to Order

Produced in our Italian factory our made to order range of Ancona® steel multi column is the largest range in the UK, allowing maximum flexibility to create a radiator that matches your exact requirements. We offer over a vast range of Ancona Multi column in 2, 3, 4, 5 and 6 column options, with 3 different mounting options wall-hung, cast feet or welded feet.

Please visit our sectional radiator builder online [theradiatorcompany.co.uk](http://theradiatorcompany.co.uk).

## Design

Prices from £27.50 per section

### Ancona® Made to Order

- 2 -6 column options
- 25 heights; 195mm up to 2500mm
- 3 mounting options; Welded Feet, Cast Feet or Standard Wall Brackets
- Up to 40 sections factory welded (40+ sections requires site assembly)
- 10-Year Guarantee
- 188 RAL colours including RAL 9016 as standard plus 31 special finishes
- Up to 4 week delivery for standard white, RAL colours and special finishes
- Up to 6 weeks for bare metal lacquer

See our full Made To Order range on pages 20-29.

For sizes available direct from stock please see pages 128-137.



## Choice

### Columns

All made to order Ancona® radiators can be specified in either 2, 3, 4, 5 or 6 column depths, this allows you to achieve the output you require in the space you have available.



### Mounting Options

Our Ancona® made to order can be mounted in one of three ways: Welded Feet, Cast Feet, and Wall Brackets. Wall Brackets will allow you to position your steel multi column radiator at any height.

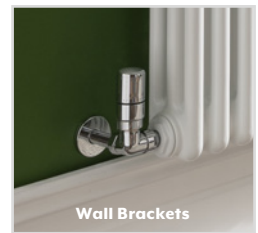
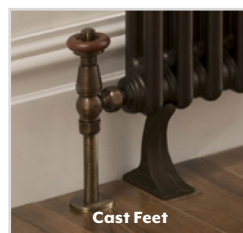

## Service

Use our [online radiator builder](http://theradiatorcompany.co.uk) to select the best solution for your room. It will take you through the process quickly and easily and allows you to save your ideas to your own Wish List. [Go to our website theradiatorcompany.co.uk](http://theradiatorcompany.co.uk)

### Valves

With Ancona you have a wide choice of valves to choose from, depending on your overall interior décor you could select our traditional valves, Vintage or the larger Vintage XL, available in a selection of traditional finishes. Or you might have a more modern scheme where the Ideal or Pistol range are better suited.

**Save up to £45 with our valve promotion, see product pages in the back of the brochure or page 118 for full details.**

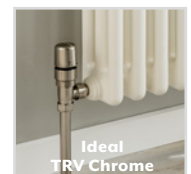
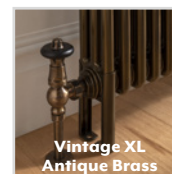

® Ancona is a registered trademark of IRSAP UK Limited.

# Ancona® - Made to Order Finishes

The Ancona® made to order range is available in 188 RAL colours including our standard white RAL 9016, a bright porcelain white. As an alternative, RAL 9010 Pure White, a soft creamier white can be specified at the standard white price. We also offer 31 special finishes including Gun Metal Grey, Textured White and Ivory, Mottled, Metallics, Golds and a Bare Metal Lacquer finish.

Please call 01342 302250 for a RAL chart and Special Finish chart.



## 188 RAL Colours

Match your room style by selecting from a full rainbow of 188 RAL colours. Use either contrasting colours to create a bold statement or sympathetic colours so your Ancona® blends in to your wall.



## 31 Special Finishes including a Bare Metal Lacquer finish

There are 31 classic colours to choose from including: metallics, mottled, textured effects, as well as bare metal lacquer finish. For a Special Finish chart please call our Customer Service team on 01342 302250.



® Ancona is a registered trademark of IRSAP UK Limited.

# Ancona<sup>®</sup> Made to Order

Welded Feet



4 column, 750mm x 926mm in Pearl Grey with Chrome Vintage TRVs.



3 column, 1800mm x 476mm in Textured Stone with Nickel Vintage XL TRVs.

# Ancona<sup>®</sup> Made to Order

## Cast Feet



3 column, 1500mm x 566mm in Mottled Copper with Antique Copper. Vintage TRVs.



4 column, 300mm x 881mm in Textured White with Nickel Vintage TRVs.

Ancona<sup>®</sup> Made to Order

Wall Brackets



3 column, 600mm x 701mm in Textured White with White Ideal TRVs.





2 column, 2000mm x 476mm in Carbon with Nickel Vintage XL TRVs.

# Ancona<sup>®</sup> Bench Seat

Horizontal Made to Order



Horizontal, 6 column, 460mm x 1350mm in Mottled White Gold with Wooden Top and Chrome Pistol TRVs.

# Ancona® Bench Seat

Vertical Made to Order



Vertical, 5 column, 496mm x 1016mm in White RAL 9016 with Wooden Top and Nickel Vintage TRVs.

# Ancona<sup>®</sup> Curved

Made to Order



Internal curve with Welded Feet, 4 column, 500mm x 1376mm in Textured Ivory.

# Ancona® Electric

Stock and Made to Order



3 Column 600mm x 843mm in White RAL 9016.

# Contemporary Designer - Stock & Made to Order

Our contemporary designer range contains models that can be used throughout the home. Developed to reflect the latest trends in design these radiators will complement any interior scheme. The wide selection of sizes, formats and colour options allows you to select the perfect radiator to suit your heat output requirements, space and interior.

Knowing the heat output required (BTU/Watts) to heat your room is key when choosing your radiator. For help on calculating this and selecting the correct size of your chosen radiator please visit our website [theradiatorcompany.co.uk](http://theradiatorcompany.co.uk)

All Stocked Designer Radiators are now delivered in 48-72 hours.

## Design

Prices from £300.00

As Italy's leading manufacturer with over 50 years experience of innovative design, we offer the widest choice of stylish high quality radiators with guarantees ranging from 10 to 20 years.



## Choice

### Aluminium

We have 4 exciting designer aluminium ranges, the Iseo, Niro, Sebino and Canto. All with the efficient features of aluminium and available in a range of sizes and colours for quick delivery. Plus we have the Odolo taking it's inspiration from traditional designs, the soft curves deliver a classic style.

Our Low Water Content radiators are designed for improved efficiency which contribute to reduced running costs while delivering great output.



For Low Water Content radiators look out for this symbol (shown left) in the technical section.

### Radiant Panels



Our Ceramica radiators are produced from what would have historically been a waste product of the production of marble worktops and tiles. This marble powder can now be fully recycled, bound together with water and eco-friendly adhesive agents and is compressed to form these high-quality products.

Made in Italy using a ground-breaking, patented technology, the use of low temperatures in the production process uses less energy and therefore has lower CO2 emissions, meaning it has a very low environmental impact. These radiators can be fully recycled, and have been designed to complement systems with renewable energy sources.

Unlike traditional radiators, the Ceramica range produces radiant heat. Compared to standard convection, radiant heat means less disturbance and distribution of dust particles, and an even and direct transfer of heat.

# Contemporary Designer - Stock & Made to Order

## Choice

### Mild Steel and Stainless Steel

There is an extensive choice of vertical, horizontal, single & double formats, as well as a variety of tube designs so you can have the right combination of design and heat output. In a range of material types such as mild and stainless steel, our designer radiators complement all types of interiors.



## Service

**All our designer models with stock sizes are now available for delivery in 48-72 hours. Every stock size is listed in bold in the price tables. Made to order radiators available in 4-9 weeks.**

Use our **online BTU (heat output) calculator** to get a guide of your room requirements which you can then check with your installer. Once you know your outputs use our **online radiator builder** to select the best solution for your room. It will take you through the process quickly and easily and allows you to save your ideas to your own Wish List. **Go to our website [theradiatorcompany.co.uk](http://theradiatorcompany.co.uk)**

### Painted Valves

You have the option to fully coordinate your designer radiator colour with your valves & pipe covers to create a unique & individual statement. Note: valves & pipe covers must be ordered at the same time as the radiator. See page 119 for full details.



**Pistol TRV in Azurite with matching Pipe Covers & Shrouds**

### Accessories

Make the most of your radiator by adding a towel bar or hanging peg. Great for kitchens, bathrooms and hallways these accessories can bring extra functionality to any radiator. See page 126 for full details.



**SAVE £45\***

**WHEN YOU BUY OUR IDEAL TRV & PIPE COVERS WITH ANY DESIGNER PURCHASE. QUOTE PROMOV1 AT TIME OF ORDER.** White or Chrome only, see product pages at the back of the brochure for full details.

\*Saving based on the value of individual items when bought separately.

Order any of our selected valves & matching pipe covers at the same time as your radiator; PROMOV1W (white), PROMOV1C (chrome).

## Finishes



### Colour Coordination Service

For selected stock ranges, products that are available for this service will have the Colour Coordination icon (shown left) on their individual technical pages. **Please see page 217 for full details and how to order.**



### 188 RAL Colours (made to order)

Match your room style by selecting from a full rainbow of 188 RAL colours. Use either contrasting colours to create a bold statement or sympathetic colours so your designer radiator blends into your wall. **For a RAL chart please call 01342 302250.**

### 30 Special Finishes (made to order)

A choice of metallics, mottled and textured effects. **For a Special Finish chart please call our Customer Service team on 01342 302250.**

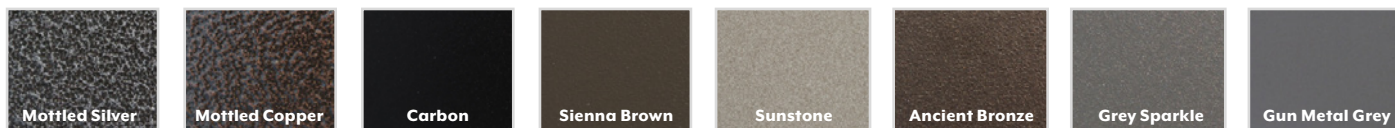

# Ceramica Collection

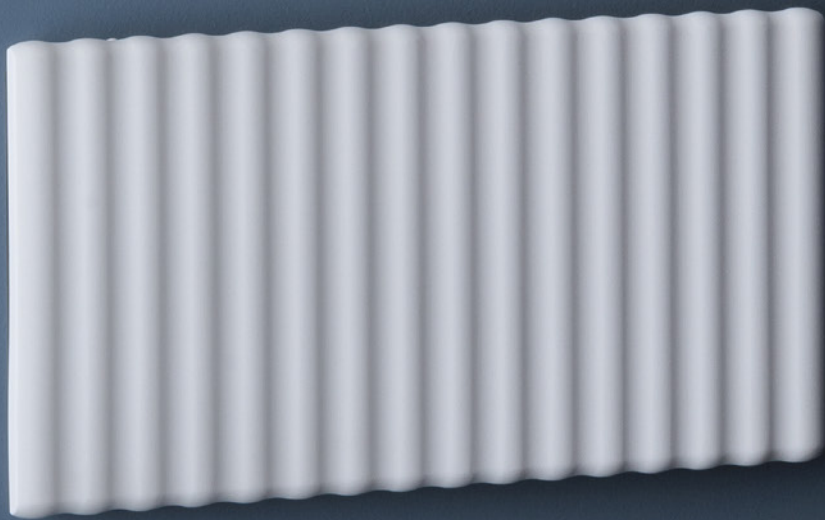

Senso Model

Varenna Model 550mm x 1100mm with integrated valves.





Pavia Model 1800mm x 300mm with integrated valves.

# Torré



Horizontal 600mm x 956mm in Textured Matt White RAL 9016 with White Ideal TRVs.



Vertical 1800mm x 356mm in special finish RAL 9007 Grey Aluminium with Chrome Corner Ideal TRVs.

# Niro



Horizontal 631mm x 799mm in White RAL 9016 with White Corner Ideal TRVs.



Vertical 1831mm x 479mm in RAL 7016 with Nickel Ideal TRVs.

Iseo



Horizontal 500mm x 1185mm in White RAL 9016 with White Ideal TRVs.



Vertical 1800mm x 335mm in RAL 7016 with matching painted Pistol TRVs.

# Sebino



Horizontal 634mm x 980mm in White RAL 9010.





New

Mati Silver finish

Vertical 1834mm x 500mm in White RAL 9010 with White Corner Ideal TRVs.

# Odolo



649mm x 1024mm in White RAL 9010 shown with White Ideal TRVs.



1849mm x 524mm in White RAL 9010 shown with White Ideal TRVs.

# Canto



668mm x 1020mm in RAL 7016 shown with Nickel Ideal TRVs.

# Ellipsis Stainless Steel



**Double 1800mm x 413 in Polished Stainless Steel with Chrome Corner Ideal TRVs.**

# Ellipsis



Double horizontal 600mm x 1020mm in RAL 7016 with Nickel Corner Ideal TRVs.



Single vertical 1820mm x 480mm shown in White RAL 9016 with Chrome Ideal TRVs.

# Sitar



Double horizontal 504mm x 1220mm in White RAL 9016 with White Ideal TRVs.





Single horizontal

Double vertical 1820mm x 402mm shown in RAL 9007 with Nickel Ideal TRVs.

# Sax



Double horizontal 520mm x 900mm shown in RAL 9016 with White Ideal TRVs.



Double vertical 1800mm x 400mm shown in RAL 9006 White Aluminium with Chrome Pistol TRVs.

# Piano



Double horizontal 456mm x 1220mm in Black Sparkle with Chrome Corner Ideal TRVs.



Double vertical 1820mm x 456mm in White RAL 9016 with Ideal TRVs.

# Water Lily



Single 2020mm x 312mm in Matt Black with Nickel Corner Ideal TRVs.

Immagina



LED Version 1800mm x 500mm shown in Black RAL 9005.

# Athena



Horizontal 410mm x 1200mm in RAL 8019 with Nickel Corner Ideal TRVs.





Vertical 1800mm x 410mm in White RAL 9016 with White Corner Ideal TRVs.

# Relax



Double horizontal 578mm x 1401mm shown in RAL 9007 with Nickel Corner Ideal TRVs.



Inox single vertical

Single vertical 1853mm x 381mm in White RAL 9016 with White Corner Ideal TRVs.

# Halo



Horizontal 133 diameter x 2000 in Matt Black 9005.



Vertical 1800mm x 155mm diameter, shown in Metallic Silver with Pistol TRVs.

# Sectional Aluminium - Stock

Smooth, clean lines and slim profiles make these ranges perfect for both new homes and as replacement radiators. Their practical functionality makes them suitable for living rooms, bedrooms, or studies and our variety of accessories can also enhance their use in kitchens, bathrooms, and hallways.

Use our online radiator builder to help select the best configuration for your room; [theradiatorcompany.co.uk](http://theradiatorcompany.co.uk).

## Sectional Aluminium is available in:

- White RAL 9010 in 48-72 hours
- 23 RALs, 30 special finishes and 6 new feature finishes available in up to 3 weeks

## Design

Prices from £252.00

### Energy Efficient & Made from Recycled Materials

- An aluminium radiator will heat up in just over half the time of a steel radiator and use 50% less water, saving money by using less fuel. This makes aluminium among the **most energy-efficient radiators available**.
- As aluminium radiators are a third lighter than steel radiators, it means they are extremely light and easy to install on any type of wall.
- Aluminium radiators are excellent heat conductors; our products have high thermal efficiency and contain a lower amount of water, therefore heating up faster than those produced with other materials. They are therefore easier to control & cost much less to run.



Low water content

With modern building methods and regulations requiring more insulation and higher U values for windows, having a more efficient heating system that can react quickly to changes in temperature and that can produce enough heat from smaller heat emitters means a more comfortable living environment and cheaper utility bills.

### All our Sectional Aluminium radiators are made in Italy and are available in 4 different profiles.



## Choice

Our Sectional Aluminium ranges boast incredible versatility with hundreds of possible size options all available from stock. Meet your size requirements with 3 to 20 sections, finished in a choice of 23 RAL colours (shown on page 216) and 30 special finishes (shown right). See our online radiator builder for more information; [theradiatorcompany.co.uk](http://theradiatorcompany.co.uk).

# Sectional Aluminium - Stock

## Service

**White models available from stock in 48-72 hours delivery. 23 RAL colours, 30 special finishes and 6 new feature finishes available in up to 3 weeks. (Please allow an extra 10 working days for orders of more than 10 radiators).**

Use our online BTU (heat output) calculator to get a guide of your room requirements which you can then check with your installer. Once you know your outputs use our online radiator builder to select the best solution for your room. It will take you through the process quickly and easily and allows you to save your ideas to your own Wish List. **Go to our website [theradiatorcompany.co.uk](http://theradiatorcompany.co.uk)**

See our Assembled options for our most popular sizes, other sizes can be made to your specification using the sectional data. Please note; delivery lead times on coloured aluminium start from when we have receipt of your chosen RAL colour number and description in writing. Please ensure the selected RAL colour number and name is included on your order to avoid potential delays.

### Painted Valves

You now have the option to fully coordinate your aluminium radiator colour with your valves and pipe covers to create a unique and individual statement. Image right is a Mix in Azurite with matching Pistol TRV, pipe covers & shrouds. Note: valves & pipe covers must be ordered at the same time as the radiator. **See page 119 for full details.**



### Aluminium Accessories

Aluminium accessories include hanging pegs, towel bars and for the Oscar and Vip, end panels to create a clean side profile, **see page 175 for more details.**



**SAVE £45\***

**WHEN YOU BUY OUR IDEAL TRV & PIPE COVERS WITH ANY ALUMINIUM PURCHASE. QUOTE **PROMOVI** AT TIME OF ORDER.** White or Chrome only, see product pages in the back of the brochure for full details.

\*Saving based on the value of individual items when bought separately.

Order any of our selected valves & matching pipe covers at the same time as your radiator; PROMOVIW (white), PROMOVIC (chrome).

**White RAL 9010 delivered in 48-72 hours**

## Feature Finishes

New

Painted in the UK, these 3 new Feature Finishes give a personal touch to any room. They join our existing range, giving 6 exciting options to choose from. Vintage Green, Satin Gold and Aged Brass sit alongside Textured Anthracite, Copper and Pearl Bronze. **See pages 130-135 for full details.**



Aged Brass



Vintage Green

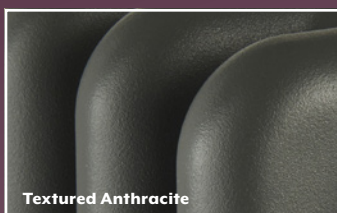

Textured Anthracite



Pearl Bronze



### 23 RAL Colours

All our Sectional Aluminium radiators are available in a selection of the 23 most popular colours from the RAL range (shades of White, Cream, Grey, Brown, Red & Black), on page 216. Available in up to 3 weeks. **Please call 01342 302250 for a RAL chart.**



### Colour Coordinating Service

Available for all sectional aluminium, **see product pages 217** for full details including process & lead times.

### Special Finish Options

Our aluminium ranges are also available in 30 exclusive special finishes (some of which are shown below), combining the efficiency of aluminium with a truly stunning finish. Available in up to 3 weeks. **Please call 01342 302250 for a Special Finish chart.**

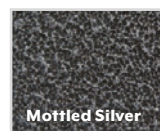

Mottled Silver

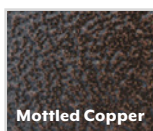

Mottled Copper

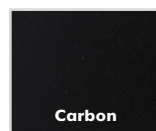

Carbon

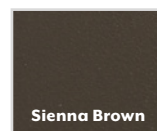

Sienna Brown

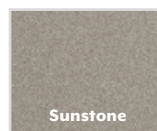

Sunstone

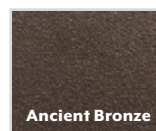

Ancient Bronze

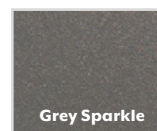

Grey Sparkle

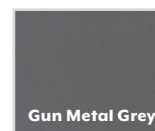

Gun Metal Grey

For orders of more than 10 radiators in colour or special finishes please allow an extra 10 working days for delivery.

Vip



590mm x 1060mm in White RAL 9010 shown with White Pistol TRVs.





790mm x 820mm in Grey Sparkle shown with Nickel Pistol TRVs.

# Oscar



1646mm x 420mm colour coordinated in Dulux Natural Slate shown with optional matching end panels and matching Pistol TRVs.



1846mm x 340mm in White RAL 9010 shown with White Ideal TRVs.

Vox



590mm x 740mm in White RAL 9010 with White Ideal TRVs.



1846mm x 340mm in RAL 9006 White Aluminium with Nickel Corner Ideal TRVs.

Mix



440mm x 1060mm in Azurite with Nickel Corner Ideal TRVs.



690mm x 1060mm in RAL 9010 with White Pistol TRVs.

# Traditional Cast Iron - Stock & Made to Order

The epitome of traditional heating, cast iron radiators are a must for any period restoration; suitable for living rooms, bedrooms, kitchens, hallways and dining rooms. Our choice of six classic designs offer the clean simplicity of “column” or the “decorative classic”. These radiators will be a perfect match for any existing radiators and being new, they come with a minimum ten year guarantee.

## Design

Prices from £35.50 per section

As a material, cast iron has its own unique properties; these radiators will hold their heat for a long time, compared to a similar steel model, although they are slower to heat up and therefore less responsive to sudden changes in temperature.

### Column

Probably the most well-known form of cast iron radiators, the original imported column models bring a real charm and character to any period property.



### Decorative Classic

The intricate and detailed designs of the Trieste and Bohemia with their tasteful scrollwork, bring a touch of splendour to your home. Our Linton range reflects the style of the 1920s, with smooth clean lines and a choice of exclusive galvanised and painted finishes.

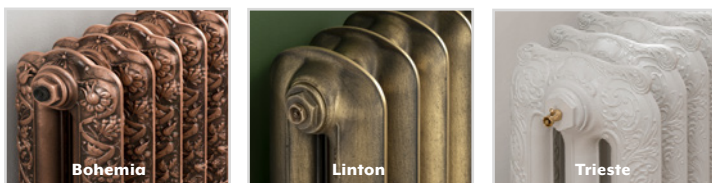

## Choice

### Sectional

Our sectional cast iron range is incredibly versatile with literally hundreds of possible sizes from a wide range of column depths & heights finished to your size. Use our online radiator builder to select the best solution for your room on our website [theradiatorcompany.co.uk](http://theradiatorcompany.co.uk).

### Mounting Options

Cast iron radiators are very heavy and therefore best mounted with floor supports. All of our ranges are available with Footed Ends as standard. The Telford & Ledbury have selected sizes without footed ends which can be sold with optional Cast Feet.

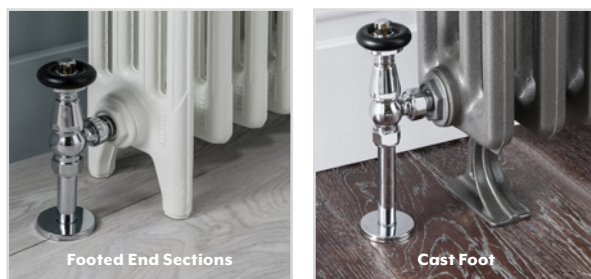

### Solid Brass Wall Ties & Airvents

Available to buy with all of our cast iron radiators, see page 189 for details.



## Service

All stocked cast iron lines are listed in bold in the technical section, primer finish delivered in 5-7 working days.

Use our online radiator builder to select the best solution for your room. It will take you through the process quickly and easily and allows you to save your ideas to your own Wish List. Go to our website [theradiatorcompany.co.uk](http://theradiatorcompany.co.uk)

Our range of valves include the classically styled Vintage TRV, Vintage XL TRV as well as the Black & Brass TRVs.



**SAVE £45\***

WHEN YOU BUY OUR VINTAGE TRV & PIPE COVERS WITH ANY CAST IRON PURCHASE. QUOTE **PROMOV2** AT TIME OF ORDER. For all Vintage TRV finishes, please see product pages in the back of the brochure for full details.

\*Saving based on the value of individual items when bought separately.  
Order any of our selected valves & matching pipe covers at the same time as your radiator.



# Cast Iron Finishes



Our range of Cast Iron radiators are available in a wide choice of finishes. We offer a choice of colour ranges and levels of finishing for you to select from. Please note; that as a result of the casting process, cast iron radiators have a rough surface finish with small imperfections which will show after the painting process.



## RAL Colours

A range of 24 of the most popular colours from the RAL range. We use a robust, polyester powder coat paint, which is applied by our specialist UK based painters, to achieve a long-lasting, durable finish. Visit page 216 for full list of RAL colours and please call 01342 302250 for a RAL chart.

Please Note; delivery lead times on coloured cast iron start from when we have receipt of your chosen RAL colour number / special finish in writing; please ensure the selected RAL colour number / special finish and name is included on your order.



## Primer Finish

Our standard finish is primer, which requires finishing to prevent rust from forming. If carried out by hand this can be a long and difficult process as cast iron is very heavy and the entire surface must be covered with an appropriate undercoat and topcoats for full protection.



## Feature Finishes

New

Painted in the UK, these 3 new Feature Finishes give a personal touch to any room. Please call customer services for colour swatches.

## Special Finishes

We can also overpaint your Ledbury, Trieste or Telford cast iron radiator in any of the special finishes in our Special finish chart including metallics, mottled & textured effects (excludes Mottled White Gold). For a Special Finish chart please call our Customer Service team on 01342 302250.



## Colour Coordination Service



In addition to the finishes listed above and below, we can also arrange for selected stocked models to be painted to reflect the colours of the most popular and premium paint brands. We can take your chosen colour and create a highly durable powder coat finish that will allow your radiator to blend in with your wall colour (or stand out if you want to make a statement!). Available for the Ledbury, Telford, and Trieste cast iron ranges only, please turn to pages 217 for full details.

## Polished

Our Aston and Linton radiators are available in a beautiful high lustre, polished finish. Created by hand, an initial black paint is used to protect hidden, hard to access areas of the radiator and to highlight the visible polished areas. The front, sides and tops of the sections are polished whilst the rear and more difficult to access areas between the sections remain black. A series of burnishing & polishing processes produces the final stunning results.

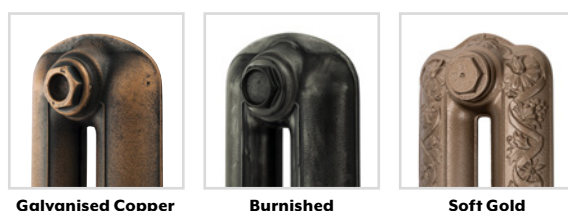

## Special & Galvanised Finishes

The Linton, Bohemmia and new Stamford range of cast iron models are available in our 24 RAL colours, 4 special finishes exclusive to the range and a galvanised copper finish. We can also burnish all three for a unique industrial look.

Please note, due to the printing process, these colours may not be representative of the true finished colour.

# Ledbury



Mini 4 column, 475mm x 1048mm in RAL 7016 with footed end sections and Nickel Vintage TRVs.



Satin Gold

6 Column, 665mm x 628mm in Matt White with Antique Brass Vintage XL TRVs.

Aston



Mini 4 column, 475mm x 1048mm in RAL 7016 with footed end sections and Nickel Vintage TRVs.



Polished finish

4 column, 760mm x 493mm in White RAL 9010 with Chrome Vintage TRVs.

Stamford

New



2 column 640mm x 770mm in Burnished finish with Nickle Vintage XL TRVs.



2 column 640mm x 524mm in white RAL 9016 with chrome Vintage XL TRVs.

# Telford



6 column, 280mm x 990mm shown in Mottled Copper with cast feet & Antique Copper Vintage TRVs.





2 column 1035mm x 690mm in White RAL 9010 with footed ends and Chrome Vintage TRVs.

Linton



3 Column, 621mm x 1098mm in Polished with Nickel Vintage XL TRV valves.



2 Column, 921mm x 442mm in Antique Brass with Antique Brass Vintage XL TRV valves.

# Trieste



**Mini 2 Column, 514mm x 1088mm in Ancient Bronze with Antique Brass Vintage XL TRVs.**



3 Column, 961mm x 804mm in Matt White with Antique Brass Vintage XL TRVs.

# Bohemia



720mm x 688mm in Burnished with Nickel Vintage XL TRVs.



Galvanised Copper

720mm x 688mm in RAL 9010 with Nickel Vintage XL TRV valves.

# Towel Rails - Stock and Made to Order

With space often at a premium, a towel rail functions as both a heat source and as a towel warmer; perfect for bathrooms, kitchens and cloakrooms.

Look out for our stocked Towel Rails delivered in 48-72 hours.

## Design

Prices from £156.00

As Italy's leading manufacturer with over 50 years experience, we offer the widest choice of stylish high-quality towel rails with guarantees ranging from 10 to 20 years.

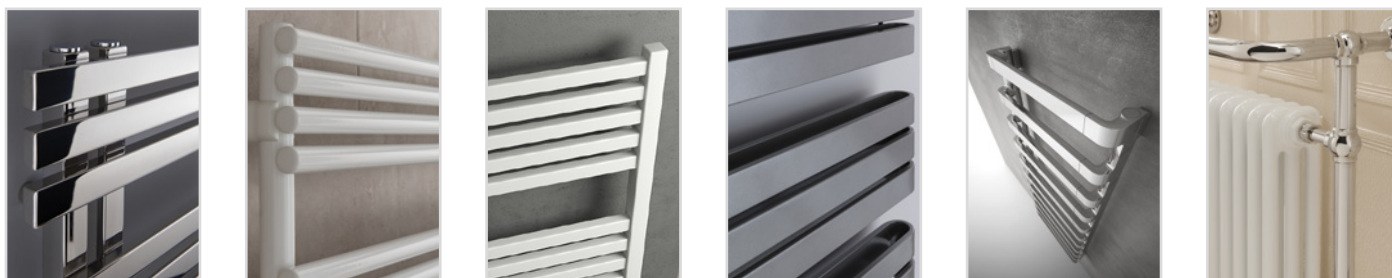

## Choice

An extensive choice of styles, from standard vertical formats to horizontal and side loading towel rails. We offer a wide variety of tube styles, including round, flat, oval, and rectangular in a range of materials; mild steel, stainless steel, and brass for the more traditional style.

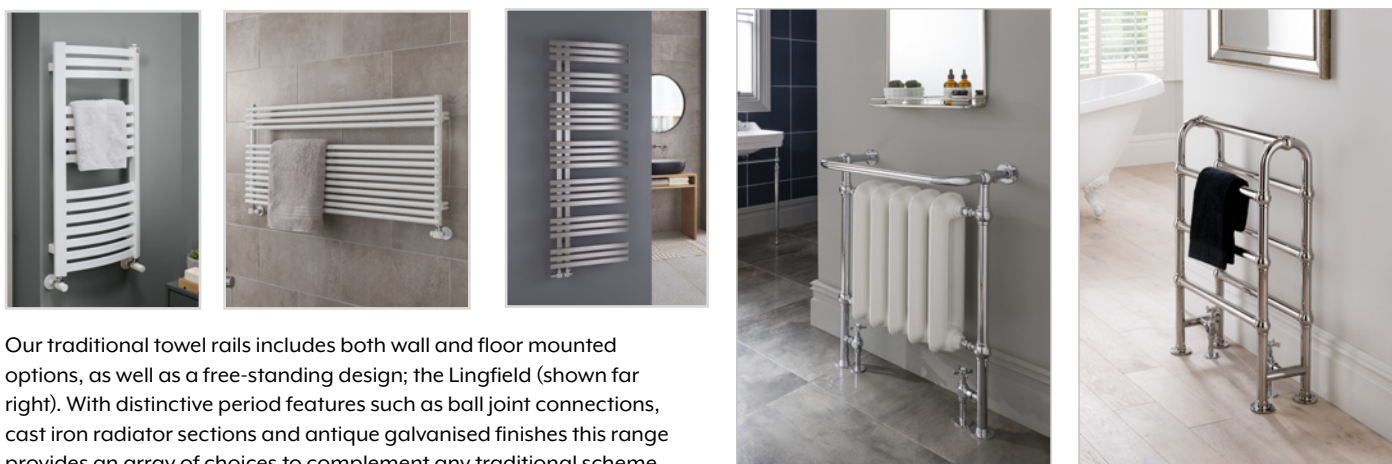

Our traditional towel rails includes both wall and floor mounted options, as well as a free-standing design; the Lingfield (shown far right). With distinctive period features such as ball joint connections, cast iron radiator sections and antique galvanised finishes this range provides an array of choices to complement any traditional scheme.

## Service

Look out for our Towel Rails which now have stock lines available for delivery in 48-72 hours; all stock lines are shown in bold in a separate 'stock' table in the technical section.

### Painted Valves

You have the option to fully coordinate your towel rail colour with your valves and pipe covers to create a unique and individual statement. Picture right shows a Lupin ladder rail in RAL 7016 with matching Cylinder valves and pipe covers and shrouds. **See page 119 for full details.**



Cylinder Valve & Pipe Covers

**SAVE £45\***

**WHEN YOU BUY OUR CYLINDER VALVE & PIPE COVERS WITH ANY TOWEL RAIL PURCHASE. QUOTE PROMOV3 AT TIME OF ORDER.** White or Chrome only, see product pages in the back of the brochure for full details.

\*Saving based on the value of individual items when bought separately.

Order any of our selected valves & matching pipe covers at the same time as your radiator; PROMOV3W (white), PROMOV3C (chrome).



# Towel Rails - Stock and Made to Order

## Electric and Dual Fuel Towel Rails



### Electric

Fully electric self-contained units that are powered by mains electricity, they can be supplied with a variety of elements, some that have complete temperature and timing options built-in, some that are basic on-off options that can be controlled by an additional control panel. These standalone towel rails allow you to install a towel rail without the need for any new pipework and can be used independently of your heating system.



Purple 'electric' symbol denotes which towel rails have fully electric models.



### Dual Fuel

Most towel rails are installed as part of a standard central heating system, but this means they will be cold when the heating is turned off in summer. With a dual fuel option, you can have the best of both worlds. Using a special valve connection, you can add an electric element to your towel rail that allows you to use your towel rail and warm your towels in the summer without having to turn on your heating.



Towel rails that can be converted will have this blue dual fuel symbol on their respective pages.



Please turn to pages 116-117 for more detailed information and prices.

## Finishes

Popular stock sizes in White RAL 9016 or Chrome are available for delivery in 48-72 hours



Aged Brass



Vintage Green



Textured Anthracite



Pearl Bronze

**Feature Finishes (Lupin & Poppy only)**  
Painted in the UK, these 3 new Feature Finishes give a personal touch to any room. Please call customer services for colour swatches.

**New**

### 188 RAL Colours

Match your bathroom, kitchen, or cloakroom style by selecting from a full rainbow of 188 RAL colours. Use either contrasting colours to create a bold statement or sympathetic colours so your Towel Rail blends into your wall. For a RAL chart please call 01342 302250.



### 30 Special Finishes

A choice of metallics, mottled and textured effects. For a Special Finish chart please call our Customer Service team on 01342 302250.



For orders of more than 10 radiators in colour or special finishes please allow an extra 10 working days for delivery.

## Step BDO



**BDO Step 430mm x 1500mm shown in White Pearl.**

# Step



Step Electric in Chrome.

Step 1240mm x 500mm shown in Chrome.

# Athena BDO



455mm x 1200mm in RAL 7040 shown with Nickel Cylinder valves.

# Athena Towel Rail



1600mm x 500mm in White RAL 9016 shown with White 3 Style Corner valves.

# Relax Bagno



1853mm x 517mm in Polished Stainless Steel with Corner Ideal TRV valves.

# Echo



1695mm x 600mm in White RAL 9016 with White Cylinder valves.

# Piano Towel Rail



Dual Fuel options see pages 116-117.



1520mm x 506mm in RAL 9006 with Chrome 3 Style Corner valves.



# Piano Lato



1260mm x 550mm in White RAL 9016 with White Cylinder valves.

Dual Fuel options see pages 116-117.

# Quadre



1216mm x 430mm in Matt Black with Chrome Mini Cube valves.

# Griffin



Dual Fuel options see pages 116-117.

1220mm x 400mm in RAL 7012 with Nickel Cylinder Valves.

# Pulsar



1224mm x 500mm in Platinum with Nickel Mini Cube valves.



Dual Fuel options see pages 116-117.

## Ellipsis Towel Rail



1380mm x 400mm shown in Platinum with Nickel Ideal TRVs.

# Sitar Lato



1348mm x 500mm in RAL 9007 with Nickel Cylinder valves.

Dual Fuel options see pages 116-117.



# Sitar BDO



543mm x 1220mm in White with White 3 Style Corner valves.

# Poll BDO

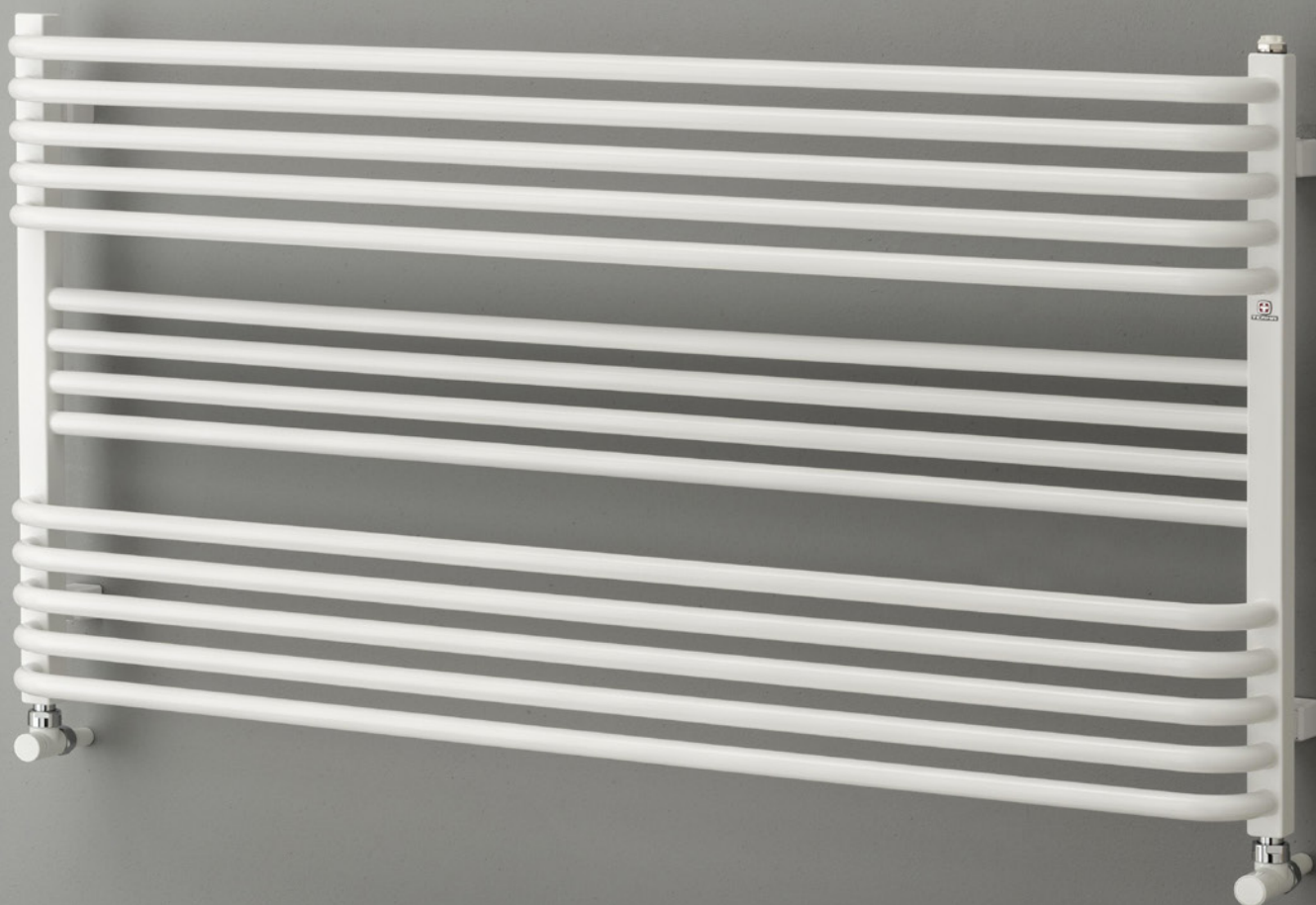

660mm x 1200mm in RAL 9016 with White Cylinder valves.



# Poll



Dual Fuel options see pages 116-117.

1480mm x 600mm shown in RAL 9016 with 3 Style Corner valves.

# Poppy



Chrome option

White 1497mm x 598mm with White Cylinder valves.



New

Satin Gold

RAL 9005 1497mm x 398mm with Chrome 3 Style Corner valves.

# Lupin



Electric Chrome option

1210mm x 600mm in Chrome with Chrome 3 Style valves.

New



White

1210mm x 500mm in new Satin Gold with matching Cylinder valves.

# Iris



Dual Fuel options see pages 116-117.

600mm x 1000mm with Chrome 3 Style Corner valves.



1200mm x 500mm shown with Chrome 3 Style Corner valves.

# Blues



1400mm x 500mm in Polished Stainless Steel with 3 Style valves.



# Chalfont Range

## Floor Standing



### Wall Hung



750mm x 500mm in Chrome

Floor Standing 938mm x 675mm in Chrome.

# Lingfield



850mm x 600mm in Chrome with Chrome Crosshead valves.

# Linton Towel Rail



RAL colours available for cast iron sections.

900mm x 490mm with White RAL 9016 cast iron sections and Chrome Crosshead valves.

# Heating Elements & Dual Fuel Kits

All available from stock and delivered in 48-72 hours.

Heating elements are used as a heat source in electric radiators, towel rails and dual fuel towel rails. You can easily install your radiator or towel rail as dual fuel by connecting it to your central heating system along with a heating element, meaning you are able to run your product as electric in the summer months.

All towel rails that can be converted to dual fuel will have a dual fuel symbol in the technical section



Follow these simple stages to select the correct Dual Fuel Kit for your towel rail.

## 1. Valve Configurations

All radiators will require a valve, select either a T-piece or a Dual Fuel valve to suit your installation.

## 2. Types of Element

There are four types of electric elements to choose from (see below and opposite).

## 3. How to choose your Element

It is important to select the correct size element for your towel rail. Too small and it will not provide enough heat, too large and it can burn out. The chart above right that shows the towel rail output in watts and the corresponding recommended size of element.

Towel Rail output range in Watts	Electric Elements
165 - 255	200w
260 - 375	300w
380 - 530	400w
535 - 735	600w
740 - 920	800w
920 - 1100	1000w

## Round Bluetooth Element

- 5 heat settings from 30°C to 60°C regulating the internal radiator temperature, denoted by 5 LED's
- Full operational control of the element on smartphone / tablet via Bluetooth (with "Terma BLUE-Line" App: iOS / Android)
- Provides a choice of internal temperature (30°C to 60°C) or ambient room temperature (15°C to 30°C) regulation.
- 7 day timer. 2 hour drying function
- Lot20 EcoDesign Directive compliant\*
- Guarantee - 2 years
- Delivered in 48-72 hours



Description	Model	Output	IP Rating	Black Ex VAT	Black Inc VAT	Silver Ex VAT	Silver Inc VAT
Round Bluetooth Element	AARBELE	120, 200, 300, 400, 600, 800, 1000 & 1200 watts	IPx5	£181.00	£217.20	£181.00	£217.20

\*Lot 20 EcoDesign Directive Compliancy - The Round & Square Bluetooth Elements (or any element fitted with the Wi-Fi Timer device) are all compliant with Lot 20; whereby an electric room radiator (does not apply to electric towel rails) has to have a weekly timer and adaptive start control/out of home control.

## Low Temperature 43D Element

- Element pre-programmed to run at an internal temperature of 43°C, for Low Surface Temperature (LST) style operation\*
- When specifying this element, to help ensure correct surface temperature, reduce the output of your radiator (as water) by 40% (i.e for a 200w towel rail install the 120w element)
- No Timer. 2 hour drying function
- Frost & overheating protection
- IPx5. Class 1.
- Guarantee - 2 years
- Delivered in 48-72 hours



Description	Model	Output	IP Rating	Silver Ex VAT	Silver Inc VAT
Low Temperature 43D Element	LT43ELE	120, 200, 300, 400, 600 & 1000 watts	IPx5	£142.00	£170.40

\*Note: Small areas of the towel rail could exceed 43° by a marginal amount during the initial heating up process

## Cable Masking Cover (for Round Bluetooth & Low Temperature elements only)



Delivered in 48-72 hours

Description	Suitable for	Model	White Ex VAT	White Inc VAT	Black Ex VAT	Black Inc VAT	Silver Ex VAT	Silver Inc VAT	Chrome Ex VAT	Chrome Inc VAT
Element Masking Cover	AARBELE & LT43ELE Models	AAMASK	£10.00	£12.00	£10.00	£12.00	£10.00	£12.00	£10.00	£12.00

# Heating Elements & Dual Fuel Kits

All available from stock and delivered in 48-72 hours.

## Digital Square Element

- 30 Heat settings from 30°C to 60°C in steps of 1°C. Regulates the internal temperature and displays this on screen.
- Daily 24hr timer. 0.5 to 4hr drying function.
- 4x Buttons: Dryer, Power, Temp +/-.
- Frost & overheating protection.
- IPx5. Class 1. Guarantee - 2 years
- Delivered in 48-72 hours



Chrome + Grey Cable



White + White Cable

Description	Model	Output	IP Rating	White Ex VAT	White Inc VAT	Chrome Ex VAT	Chrome Inc VAT
Digital Square Element	AADSELE	120, 200, 300, 400, 600 & 1000 watts	IPx5	£164.00	£196.80	£183.00	£219.60

## Square Bluetooth Element Bluetooth®

- Full operational control of the element on smartphone/tablet via Bluetooth (with "Terma BLUE-Line" App: IOS/ANDROID).
- Provides a choice of internal temp (30°C to 60°C) or ambient room temp (15°C to 30°C) regulation.
- 7 day timer. 1-4hr drying function.
- Lot20 EcoDesign Directive compliant\*
- Frost & overheating protection.
- IPx5. Class 1. Guarantee - 2 years
- Delivered in 48-72 hours



Chrome + Grey Cable



White + White Cable



Black + Black Cable



Silver + Grey Cable

Description	Model	Output	IP Rating	White Ex VAT	White Inc VAT	Black / Silver Ex VAT	Black / Silver Inc VAT	Chrome Ex VAT	Chrome Inc VAT
Square Bluetooth Element	AASBELE	120, 200, 300, 400, 600, 800 & 1000 watts	IPx5	£222.00	£266.40	£232.00	£278.40	£242.00	£290.40

## Corner TRV Valve for Dual Fuel

- This valve is ideal for dual fuel as it incorporates a TRV, Lockshield with an integrated T Piece, to accommodate the element.
- Valve colour: Chrome
- Delivered in 48-72 hours



Image shows left hand option

Description	Model	Chrome Ex VAT	Chrome Inc VAT
Dual Fuel TRV Valve - Right Hand	VVDFTRVRH	£232.00	£278.40
Dual Fuel TRV Valve - Left Hand	VVDFTRVLH		

## T-Piece (for Dual Fuel)

- A T Piece is required for Dual Fuel installation as it allows both an element and a valve to be fitted to the same tapping on a radiator.
- We offer one type of valve where no T Piece is required (detailed above). Or you can source your own standard pair of valves to fit along with this T Piece.
- Delivered in 48-72 hours



White

Chrome

Matt Black

Matt Silver

Description	Model	Price Ex VAT	Price Inc VAT
White T-Piece (for Dual Fuel)	AATPIECEW	£12.00	£14.40
Matt Black T-Piece (for Dual Fuel)	AATPIECEB	£12.00	£14.40
Matt Silver T-Piece (for Dual Fuel)	AATPIECES	£12.00	£14.40
Chrome T-Piece (for Dual Fuel)	AATPIECEC	£15.00	£18.00

## Fused Spur with Programmer

- Combination fused spur & 7 day timer in one. Fully controllable from anywhere in the world via free app (ANDROID & IOS).
- 40mm projection. Fits over standard flush or surface mount back box - 32mm deep.
- 3kw load capacity.
- Non IP Rated - install outside bathroom.



Description	Model	Price Ex VAT	Price Inc VAT
Fused Spur and Wifi Timer Combination Device	AAFWSWTIMER	£165.00	£198.00

Delivered in 48-72 hours

# Valves

Every Radiator needs a pair of valves to operate. A good quality valve not only benefits from efficient performance they also add to the appearance of your finished radiator. All our valves have a 5 year warranty and can be delivered within 48-72 hours.

## Wheelhead and Lockshield

Every Radiator requires a pair of valves that work together, the Wheelhead adjusts the flow of water into the radiator and the Lockshield balances the flow of water around the whole system, ensuring each radiator heats up at the same rate, these should be adjusted by your installer.

## TRV or Manual?

Thermostatic Radiator Valves (TRVs) monitor the room temperature. They usually have between 4 to 6 levels and the valve opens and closes automatically to reach and maintain the desired level. TRVs can help maximise the efficiency of your system reducing energy consumption and are now a requirement as part of building regulations relating to new builds and refurbishments.

Manual valves are adjusted by hand; they allow a constant flow of water through your radiator regardless of the room temperature and radiators will only turn off when the main thermostat reaches its set point or the programmer turns the heating off.

## Angled, Corner or Straight?



## Pipework and Pipe centres

All our valves have 15mm connections as standard unless otherwise stated; if you need different connections please specify when ordering your valves. The use of plastic pipe has become more popular; however, our valves are not designed to operate with plastic pipes. Also, if chrome pipework is used most valves will not grip it securely because chrome is a harder surface than copper or iron and leaks can occur. Special fittings are required to enable valves to grip chrome pipe work and these must be specified at time of order. The position of the pipework for your radiator will be affected by the valves you select. All angled valves have a dimension to allow for adjusting pipe work. You should make adequate allowances for manufacturing tolerances in pipe centres. For straight valves, a minimum of 150mm should be allowed from the base of the radiator for ease of installation.

**Please note:** We will always supply angled valves as standard, if you require straight please specify at time of order. We endeavour to ensure all pipe centres are correct, however manufacturing tolerances must be considered; we strongly recommend that pipe work is not altered or adjusted until the new radiator or towel rail is fitted. The Radiator Company will not accept any responsibility for claims resulting from incorrect pipe centres.

# SAVE £45\*

## WHEN YOU BUY OUR SELECTED VALVES AND MATCHING PIPE COVERS WITH ANY RADIATOR OR TOWEL RAIL ORDER.

Saving based on the value of individual items when bought separately. Order any of our selected valves & matching pipe covers at the same time as your radiator quoting the relevant promo code below. See individual product pages for details.

### IDEAL TRV (white / chrome)



Please quote **PROMOV1**  
(specifying 'W' for white or 'C' chrome)

### VINTAGE TRV (any finish)



Please quote **PROMOV2**  
(please specify your finish at time of order)

### CYLINDER VALVE (white / chrome)



Please quote **PROMOV3**  
(specifying 'W' for white or 'C' chrome)

# Painted Valves



Create a unique and individual statement with your valves and pipe covers. The valves pictured below can be painted in the same colour as your radiator from one of our 23 RAL colours shown on page 216, 30 Special Finishes and 6 new Feature Finishes.

Pictured right is a Lupin Towel Rail in RAL 7016 with matching painted Cylinder valves and pipe covers and shrouds. Painted valves are delivered in up to 3 weeks.

**Please note:** Painted valves & pipe covers can only be ordered in the same colour and at the same time you order your painted radiator and can not be purchased separately.

To provide complete coordination, simply follow these three easy steps:

## 1. Select your valve



**Pistol TRV**  
(shown in Azurite)

Description	Model	Colour Ex VAT	Colour Inc VAT
DELIVERY TIMES		UP TO 3 WEEKS	
Angled or Straight	VVPISLTRV	£307.00	£368.40



**Cylinder**  
(shown in RAL 7016)

Description	Model	Colour Ex VAT	Colour Inc VAT
DELIVERY TIMES		UP TO 3 WEEKS	
Angled or Straight	VVCYL	£213.00	£255.60



**Crosshead**  
(shown in Mottled Copper)

Description	Model	Colour Ex VAT	Colour Inc VAT
DELIVERY TIMES		UP TO 3 WEEKS	
Angled or Straight	VVCRO	£302.00	£362.40

## 2. Select your colour from a choice of 23 RAL colours and 30 special finishes and 6 new feature finishes

There are 23 RAL colours and 30 special finishes to choose from including metallics, mottled and textured effects.

For a RAL or Special Finish chart please call our Customer Service team on 01342 302250.

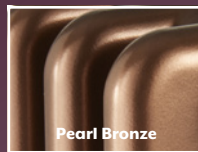
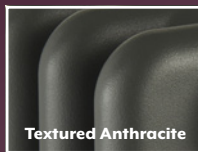
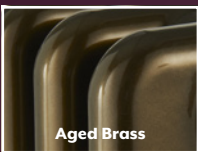
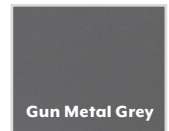
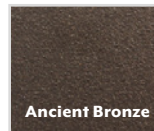
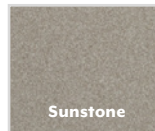
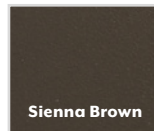
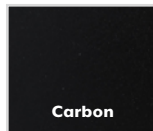

### Feature Finishes

Available when purchasing products painted in Feature Finishes only (see pages 12-15 & 130-135). Please call customer services for sample swatches.

New

## 3. Select matching pipe covers and shrouds

We can also match the colour of the pipe covers and pipe shrouds for your radiators or towel rails in any one of the colour options shown above. Each pair of painted pipe covers comes with matching shrouds.

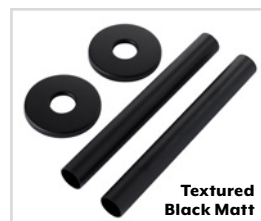

Description	Model	Colour Ex VAT	Colour Inc VAT
DELIVERY TIMES		UP TO 3 WEEKS	
Pipe Covers (Pair)	AAPIPECOVR	£145.00	£174.00

Each set is supplied with 2 x 160mm pipe covers & 2 shrouds. Delivery on coloured pipe covers is up to 3 weeks.

# TRV Valves

Stocked valves are listed in bold & will be delivered in 48-72 hours.

## Corner Ideal TRV shown on pages 12, 37, 48 & 54

Available in six finishes  
Delivered in 48-72 hours.



Chrome Corner Ideal TRV on Ancona\*



Chrome Wheelhead & Lockshield

<b>Pipe Centers</b> For corner valves allow an extra 90mm in total	<b>Valve Height</b> 116mm	<b>Please Note</b> Corner Ideal TRV valves are not Bi-directional
---	------------------------------	--



Antique Brass



White



Black



Nickel



Antique Copper

Description	Model	Chrome Ex VAT	Chrome Inc VAT	White Ex VAT	White Inc VAT	Nickel Ex VAT	Nickel Inc VAT	Black Ex VAT	Black Inc VAT	Antique Copper Ex VAT	Antique Copper Inc VAT	Antique Brass Ex VAT	Antique Brass Inc VAT
Corner only	VVCOIDTRV	<b>£173.00</b>	<b>£207.60</b>	<b>£173.00</b>	<b>£207.60</b>	<b>£242.00</b>	<b>£290.40</b>	<b>£242.00</b>	<b>£290.40</b>	<b>£242.00</b>	<b>£290.40</b>	<b>£242.00</b>	<b>£290.40</b>



# TRV Valves

Stocked valves are listed in bold & will be delivered in 48-72 hours.

## Ideal TRV shown on pages 13, 36, 45 & 55.

Available in six finishes, in angled or straight options, the Ideal TRV is a great value Thermostatic valve.

Delivered in 48-72 hours.



Nickel Angled Ideal TRV on Ancona\*



Nickel

Pipe Centers For angled valves allow an extra 80mm in total	Valve Height 125mm	Please Note Ideal TRV valves are not Bi-directional
--	-----------------------	--



Chrome



Antique Brass



Antique Copper



Black



White

Please note:

All valves are sold in pairs, a lockshield and a wheelhead. Angled will be supplied as standard, please specify if you require straight valves.

Description	Model	Chrome Ex VAT	Chrome Inc VAT	White Ex VAT	White Inc VAT	Nickel Ex VAT	Nickel Inc VAT	Black Ex VAT	Black Inc VAT	Antique Copper Ex VAT	Antique Copper Inc VAT	Antique Brass Ex VAT	Antique Brass Inc VAT
Angled or straight	VVIDETRV	<b>£166.00</b>	<b>£199.20</b>	<b>£166.00</b>	<b>£199.20</b>	<b>£205.00</b>	<b>£246.00</b>	<b>£205.00</b>	<b>£246.00</b>	<b>£205.00</b>	<b>£246.00</b>	<b>£205.00</b>	<b>£246.00</b>

## Ideal TRV Kits

Ideal TRV Kit consists of valves, pipe covers and shrouds, saving up to £21.00 compared to when bought separately.



Description	Model	Chrome Ex VAT	Chrome Inc VAT	White Ex VAT	White Inc VAT	Nickel Ex VAT	Nickel Inc VAT	Black Ex VAT	Black Inc VAT	Antique Copper Ex VAT	Antique Copper Inc VAT	Antique Brass Ex VAT	Antique Brass Inc VAT
Valve, Cover and Shroud Kit	VVIDETRVKIT	<b>£198.00</b>	<b>£237.60</b>	<b>£198.00</b>	<b>£237.60</b>	<b>£238.00</b>	<b>£285.60</b>	<b>£238.00</b>	<b>£285.60</b>	<b>£238.00</b>	<b>£285.60</b>	<b>£238.00</b>	<b>£285.60</b>

# Traditional Valves

Stocked valves are listed in bold & will be delivered in 48-72 hours.

## Vintage TRV shown on pages 20, 22, 27, 76 & 79

The Vintage TRV valve offers great value.

- Made from die-cast brass
- Best suited to 2, 3, & 4 column Ancona's®
- Height 115mm
- Weight 460g
- Available from stock in 48-72 hours
- Made in Italy

Pipe Centers For angled valves allow an extra 90mm in total	Valve Height 115mm	Please Note Vintage TRV valves are not Bi-directional
--	-----------------------	--



Nickel Angled Wheelhead & Lockshield (Black Top)



Antique Copper Wheelhead (Walnut Top)



Polished Brass Wheelhead (Walnut Top)



Chrome Wheelhead (Black Top)



Antique Brass Wheelhead (Walnut Top)

Description	Model	Polished Brass Ex VAT	Polished Brass Inc VAT	Chrome Ex VAT	Chrome Inc VAT	Nickel Ex VAT	Nickel Inc VAT	Antique Brass Ex VAT	Antique Brass Inc VAT	Antique Copper Ex VAT	Antique Copper Inc VAT
Vintage TRV Angled	VVVINTRV	<b>£192.00</b>	<b>£230.40</b>	<b>£205.00</b>	<b>£246.00</b>	<b>£276.00</b>	<b>£331.20</b>	<b>£268.00</b>	<b>£321.60</b>	<b>£268.00</b>	<b>£321.60</b>
Vintage TRV Straight	VVVINTRV	£219.00	£262.80	<b>£236.00</b>	<b>£283.20</b>	£331.00	£397.20	£320.00	£384.00	£320.00	£384.00

Please note: all valves are sold in pairs, a lockshield & a wheelhead. Angled supplied as standard, please specify if you require straight valves. Straight Vintage TRV valves in Chrome are available from stock in 48-72 hours, all other finishes will be delivered in 5 weeks.

## Vintage TRV Kit

Kit consists of valves, pipe covers and shrouds, save up to £25.00 when buying the Vintage TRV Kit (see page 123 for images).

Description	Model	Polished Brass Ex VAT	Polished Brass Inc VAT	Chrome Ex VAT	Chrome Inc VAT	Nickel Ex VAT	Nickel Inc VAT	Antique Brass Ex VAT	Antique Brass Inc VAT	Antique Copper Ex VAT	Antique Copper Inc VAT
Angled Valve, Cover and Shroud Kit	VVVINTRVKIT	<b>£226.00</b>	<b>£271.20</b>	<b>£238.00</b>	<b>£285.60</b>	<b>£307.00</b>	<b>£368.40</b>	<b>£297.00</b>	<b>£356.40</b>	<b>£297.00</b>	<b>£356.40</b>
Straight Valve, Cover and Shroud Kit	VVVINTRVKIT	£251.00	£301.20	<b>£268.00</b>	<b>£321.60</b>	£364.00	£436.80	£354.00	£424.80	£354.00	£424.80

## Vintage TRV special corner valves

Vintage TRV valves are available in a selection of handed return angled valve options. Return angled valves are left and right-handed, you can select the correct option by identifying which side of the radiator has the flow connection; e.g flow connection on the left side requires a left-hand wheelhead and matching lockshield.

Please specify left or right-hand return for the wheelhead when ordering the return angled valves, Chrome is available from stock in 48-72 hours, delivery is 5 weeks for all other finishes. **Please call 01342 302250 for more information.**

Description	Model	Polished Brass Ex VAT	Polished Brass Inc VAT	Chrome Ex VAT	Chrome Inc VAT	Nickel Ex VAT	Nickel Inc VAT	Antique Brass Ex VAT	Antique Brass Inc VAT	Antique Copper Ex VAT	Antique Copper Inc VAT
Angled to Wall	VVVINTRV	£238.00	£285.60	<b>£257.00</b>	<b>£308.40</b>	£364.00	£436.80	£349.00	£418.80	£349.00	£418.80



Left-hand return angled valve in Chrome

# Traditional Valves

Stocked valves are listed in bold & will be delivered in 48-72 hours.



Nickel Angled Wheelhead & Lockshield (Black Top)

## Vintage XL TRV

shown on pages 16, 17, 25, 28 & 83.

The Vintage XL TRVs large size creates an impactful presence.

- Made from die-cast brass
- Best suited to 5 & 6 column Ancona's® and Cast Iron radiators
- Height 160mm
- Weight 881g
- Available from stock in 48-72 hours
- Made in Italy

Pipe Centers For angled valves allow an extra 120mm in total	Valve Height 160mm	Please Note Vintage XL TRV valves are not Bi-directional
---	-----------------------	---



Polished Brass Wheelhead (Walnut Top)



Chrome Wheelhead (Black Top)



Antique Copper Wheelhead (Walnut Top)



Antique Brass Wheelhead (Black Top)

Description	Model	Polished Brass Ex VAT	Polished Brass Inc VAT	Chrome Ex VAT	Chrome Inc VAT	Nickel Ex VAT	Nickel Inc VAT	Antique Brass Ex VAT	Antique Brass Inc VAT	Antique Copper Ex VAT	Antique Copper Inc VAT
Angled	VVVINXLTRV	<b>£374.00</b>	<b>£448.80</b>	<b>£391.00</b>	<b>£469.20</b>	<b>£468.00</b>	<b>£561.60</b>	<b>£468.00</b>	<b>£561.60</b>	<b>£468.00</b>	<b>£561.60</b>

Please note: all valves are sold in pairs, a lockshield & a wheelhead. Angled only.

## Vintage XL TRV Kit

Kit consists of valves, pipe covers and shrouds, save up to £24.00 when buying the Vintage XL TRV Kit.



Description	Model	Polished Brass Ex VAT	Polished Brass Inc VAT	Chrome Ex VAT	Chrome Inc VAT	Nickel Ex VAT	Nickel Inc VAT	Antique Brass Ex VAT	Antique Brass Inc VAT	Antique Copper Ex VAT	Antique Copper Inc VAT
Valve, Cover and Shroud Kit	VVVINXLKIT	<b>£406.00</b>	<b>£487.20</b>	<b>£421.00</b>	<b>£505.20</b>	<b>£499.00</b>	<b>£598.80</b>	<b>£499.00</b>	<b>£598.80</b>	<b>£499.00</b>	<b>£598.80</b>

# Traditional Valves

Stocked valves are listed in bold & will be delivered in 48-72 hours.

## Black & Brass TRV

Delivered in 48-72 hours.



Brass Angled Wheelhead & Lockshield



Brass Straight Wheelhead & Lockshield



Chrome Straight Wheelhead & Lockshield



Chrome Angled Wheelhead & Lockshield

<b>Pipe Centers</b> For angled valves allow an extra 80mm in total	<b>Valve Height</b> 127mm	<b>Please Note</b> Black & Brass TRV valves are not Bi-directional
---	------------------------------	---

Description	Model	Brass Ex VAT	Brass Inc VAT	Chrome Ex VAT	Chrome Inc VAT
Angled or straight	VVNB&BTRV	<b>£187.00</b>	<b>£224.40</b>	<b>£196.00</b>	<b>£235.20</b>

Please note: all valves are sold in pairs, a lockshield and a wheelhead. Angled will be supplied as standard, please specify if you require straight valves.

## Pistol TRV shown on pages 53, 61, 63 & 73

Available in three standard finishes as well as painted options (see page 119), the Pistol TRV is available in angled or straight configurations.

Delivered in 48-72 hours.

<b>Pipe Centers</b> For angled valves allow an extra 80mm in total	<b>Valve Height</b> 128mm	<b>Please Note</b> Pistol TRV valves are not Bi-directional
---	------------------------------	--



Chrome Angled Wheelhead & Lockshield (shown in the fully open position)



White Angled Wheelhead



Nickel Angled Wheelhead

## Standard Finishes

Description	Model	Chrome Ex VAT	Chrome Inc VAT	White Ex VAT	White Inc VAT	Nickel Ex VAT	Nickel Inc VAT
Angled or Straight	VVPISLTRV	<b>£228.00</b>	<b>£273.60</b>	<b>£236.00</b>	<b>£283.20</b>	<b>£317.00</b>	<b>£380.40</b>

Please note: all valves are sold in pairs, a lockshield and a wheelhead. Angled will be supplied as standard, please specify if you require straight valves.

## Pistol TRV Kits

Pistol TRV Kit consists of valves, pipe covers and shrouds, save up to £25.00.

Description	Model	Chrome Ex VAT	Chrome Inc VAT	White Ex VAT	White Inc VAT	Nickel Ex VAT	Nickel Inc VAT
Valve, Cover and Shroud Kit	VVPISLTRVKIT	<b>£257.00</b>	<b>£308.40</b>	<b>£268.00</b>	<b>£321.60</b>	<b>£347.00</b>	<b>£416.40</b>



# Manual Valves for towel rails

Stocked valves are listed in bold & will be delivered in 48-72 hours.

## 3 Style Corner Valve

shown on pages 93, 96 & 103.



<b>Pipe Centers</b> For angled valves allow an extra 80mm in total	<b>Valve Height</b> 55mm	<b>Please Note</b> 3Style valves are not Bi-directional
---	-----------------------------	--

Description	Model	White Ex VAT	White Inc VAT	Chrome Ex VAT	Chrome Inc VAT	Silver Ex VAT	Silver Inc VAT
Angled or straight	VV3STY	<b>£189.00</b>	<b>£226.80</b>	<b>£164.00</b>	<b>£196.80</b>	<b>£208.00</b>	<b>£249.60</b>

Please note: all valves are sold in pairs, a lockshield and a wheelhead. Angled will be supplied as standard, please specify if you require straight valves.

## Mini Cube

shown on pages 98 & 100.



<b>Pipe Centers</b> For angled valves allow an extra 72mm in total	<b>Valve Height</b> 79mm	<b>Please Note</b> Mini Cube valves are not Bi-directional
---	-----------------------------	---

Description	Model	White Ex VAT	White Inc VAT	Chrome Ex VAT	Chrome Inc VAT	Nickel Ex VAT	Nickel Inc VAT
Angled Only	VVMICUAN	<b>£192.00</b>	<b>£230.40</b>	<b>£192.00</b>	<b>£230.40</b>	<b>£233.00</b>	<b>£279.60</b>

## Crosshead

shown on pages 114 & 115.



<b>Pipe Centers</b> For angled valves allow an extra 80mm in total	<b>Valve Height</b> 110mm	<b>Please Note</b> Crosshead valves are not Bi-directional
---	------------------------------	---

Valves are sold in pairs, a lockshield and a wheelhead. Angled supplied as standard, please specify if you require straight valves.

Description	Model	Chrome Ex VAT	Chrome Inc VAT	Antique Copper Ex VAT	Antique Copper Inc VAT	Nickel Ex VAT	Nickel Inc VAT
Angled or straight	VVCRO	<b>£193.00</b>	<b>£231.60</b>	<b>£257.00</b>	<b>£308.40</b>	<b>£302.00</b>	<b>£362.40</b>

This valve can be painted in a choice of 23 RAL colours and 30 Special Finishes and 6 new Feature Finishes, see page 119

## Cylinder

shown on pages 102, 104 & 106.



<b>Pipe Centers</b> For angled valves allow an extra 80mm in total	<b>Valve Height</b> 85mm	<b>Please Note</b> Cylinder valves are not Bi-directional
---	-----------------------------	--

Valves are sold in pairs, a lockshield and a wheelhead. Angled supplied as standard, please specify if you require straight valves.

Description	Model	White Ex VAT	White Inc VAT	Chrome Ex VAT	Chrome Inc VAT	Nickel Ex VAT	Nickel Inc VAT
Angled or straight	VVCYL	<b>£124.00</b>	<b>£148.80</b>	<b>£124.00</b>	<b>£148.80</b>	<b>£150.00</b>	<b>£180.00</b>

This valve can be painted in a choice of 23 RAL colours and 30 Special Finishes and 6 new Feature Finishes, see page 119

# Pipe Covers & Shrouds

Available in 7 set colours; White, Chrome, Antique Copper, Nickel, Polished Brass, Antique Brass & Black.

Pipe covers and shrouds are the perfect method of creating a neat finish for your radiators. They remove the need to paint copper pipes and hide unsightly holes drilled in the floor or wall for the feed pipe.

Available in 7 standard finishes, they can be delivered in 48-72 hours.

Each set is supplied with two 160mm covers and two shrouds.



Description	Model	Chrome Ex VAT	Chrome Inc VAT	Polished Brass Ex VAT	Polished Brass Inc VAT	White Ex VAT	White Inc VAT	Nickel Ex VAT	Nickel Inc VAT	Antique Copper Ex VAT	Antique Copper Inc VAT	Antique Brass Ex VAT	Antique Brass Inc VAT	Black Ex VAT	Black Inc VAT
DELIVERY TIMES		48-72 HOURS								48-72 HOURS					
Pipe covers	AAPIPECOV	£47.00	£56.40	£47.00	£56.40	£47.00	£56.40	£54.00	£64.80	£54.00	£64.80	£54.00	£64.80	£54.00	£64.80

Save money when you buy your pipe covers and shrouds as part of a valve kit, see page 118 for more information.

## Accessorise your Radiator

These towel bars are designed to fit our round-tubed designer radiators as well as selected models of our oval and rectangular tubed radiators in both single and double configurations, ideal for providing additional hanging space in your kitchen or bathroom to air towels or hang bathrobes. Available in White, Chrome plus 188 RAL Colours & 30 Special Finishes.

**White & Chrome delivered in 48-72 hours**, Colours delivered in up to 3 weeks.

### Towel Bars

Description	Length	Model	White Ex VAT	White Inc VAT	Colour Ex VAT	Colour Inc VAT	Chrome Ex VAT	Chrome Inc VAT
DELIVERY TIMES			48-72 HOURS		UP TO 3 WEEKS		48-72 HOURS	
Round Hanging Bar - Small	370mm	AAHB370	£61.00	£73.20	£78.00	£93.60	£89.00	£106.80
Round Hanging Bar - Large	480mm	AAHB480	£68.00	£81.60	£84.00	£100.80	£102.00	£122.40
Square Hanging Bar - Small	450mm	AAHB450	£61.00	£73.20	£78.00	£93.60	£89.00	£106.80
Square Hanging Bar - Large	550mm	AAHB550	£68.00	£81.60	£84.00	£100.80	£102.00	£122.40



### Hanging Pegs

Description	Height	Model	White Ex VAT	White Inc VAT	Colour Ex VAT	Colour Inc VAT	Chrome Ex VAT	Chrome Inc VAT
DELIVERY TIMES			48-72 HOURS		UP TO 3 WEEKS		48-72 HOURS	
Square Hanging Peg	50mm	AAHPSQ50	£61.00	£73.20	£77.00	£92.40	£83.00	£99.60
Round Hanging Peg	55mm	AAHPRO55	£61.00	£73.20	£77.00	£92.40	£83.00	£99.60



A nominal £5 charge for postage & packing will be applied to any orders under £50 in value.

# Ancona® Accessories

## Ancona® Towel Bars & Pegs

Adapt your Ancona® for the bathroom or kitchen with a towel bar or peg.

**Available from stock.**

### Towel Bars

Ancona's must be a minimum of 8 sections wide in order for a towel bar to fit

Description	Model	Price Ex VAT	Price Inc VAT
DELIVERY TIMES		<b>48-72 HOURS</b>	
To fit 8 sections or more	PPANCSTB08	<b>£70.00</b>	<b>£84.00</b>
To fit 10 sections or more	PPANCSTB10	<b>£83.00</b>	<b>£99.60</b>

*Please Note: The towel bar will sit off centre for Ancona radiators that have an uneven number of sections.*



Ancona® Towel Bar Chrome



Ancona® Towel Bar Chrome

### Pegs

Description	Model	Chrome Ex VAT	Chrome Inc VAT	Colour Ex VAT	Colour Inc VAT
DELIVERY TIMES		<b>48-72 HOURS</b>		UP TO 3 WEEKS	
Square 50mm Peg	PPANCSSQ50	<b>£83.00</b>	<b>£99.60</b>	£77.00	£92.40
Round 55mm Peg	PPANCRO55	<b>£83.00</b>	<b>£99.60</b>	£77.00	£92.40



Ancona® Pegs Chrome

## Optional Solid Brass Wall Ties & Airvents

These solid brass wall ties provide a stylish finishing touch to any Ancona® radiator; select to match your valves.

Available as a kit including matching airvent and blanking plug in Antique Brass, Chrome, Polished Brass and Brushed Nickel.

Please note these wall ties and airvents are an optional extra and do not come as standard with your Ancona® radiator.

Description	Model	Number of Wall Ties	Number of Airvents	Number of Blanking Plugs	Price Ex VAT	Price Inc VAT
DELIVERY TIMES					<b>48-72 HOURS</b>	
Single Wall Tie	PPANWT	1	N/A	N/A	<b>£68.00</b>	<b>£81.60</b>
Single Airvent & Blanking Plug	PPLAVBP	N/A	1	1	<b>£18.00</b>	<b>£21.60</b>
Wall Tie, Airvent & Blanking Plug Kit	PPANWTAVKIT2	2	1	1	<b>£149.00</b>	<b>£178.80</b>
Wall Tie, Airvent & Blanking Plug Kit	PPANWTAVKIT3	3	1	1	<b>£211.00</b>	<b>£253.20</b>
Wall Tie, Airvent & Blanking Plug Kit	PPANWTAVKIT4	4	1	1	<b>£276.00</b>	<b>£331.20</b>
Wall Tie, Airvent & Blanking Plug Kit	PPANWTAVKIT5	5	1	1	<b>£340.00</b>	<b>£408.00</b>

Antique Brass

Chrome

Polished Brass

Brushed Nickel

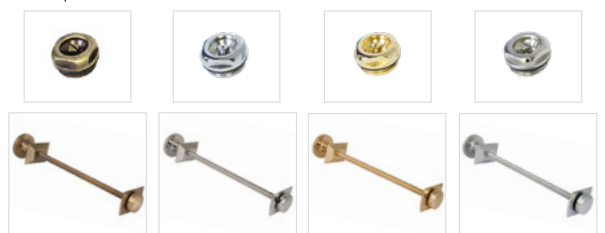

### Manual Brass Airvents

As an alternative, why not order an Ancona® manual brass airvent to co-ordinate with your chosen colour or to match your valve. 1 airvent is needed per Ancona® radiator; please specify at time of order. **Available from stock.**

Description	Model	Price Ex VAT	Price Inc VAT
DELIVERY TIMES		<b>48-72 HOURS</b>	
Brass airvent	PPAVB	<b>£4.00</b>	<b>£4.80</b>



® Ancona is a registered trademark of IRSAP UK Limited

**A nominal £5 charge for postage & packing will be applied to any orders under £50 in value.**

# Ancona® Stock pages 8-15



High quality Italian design & manufacture.  
Steel multi column 45mm sections. CE/UKCA approved & certified to BS EN442.

White RAL 9016 as standard, Feature Finishes: Copper, Pearl Bronze, Textured Anthracite, Vintage Green, Aged Brass and Satin Gold.  
(Please call **01342 302250** for sample swatches). Colour Coordination Service available, see page 217 for full details.

**Stock White RAL 9016: 48-72 Hours**

Feature Finishes: Up to 3 weeks

45

All sections  
45mm wide



**SAVE £45\***

WHEN YOU BUY OUR VINTAGE TRV & PIPE COVERS WITH ANY ANCONA® PURCHASE.  
QUOTE **PROMOV2** AT TIME OF ORDER.

\*Saving based on the value of individual items when bought separately.  
Order any of our selected valves and matching pipe covers at the same time as your radiator.

## Online Radiator Builder

Use our **NEW ONLINE RADIATOR BUILDER** to help you select the best solution for your room. It will take you through the process quickly and easily and allows you to save your ideas to your own Wish List. To select the right size of radiator for your room you need to calculate the BTU (heat output) you require to heat your room, you can use our online calculator to work this out.

Go to our new website [theradiatorcompany.co.uk](http://theradiatorcompany.co.uk)

Edit Build	
<b>Build Summary</b>	
Radiator Columns	3
Height & Length	H 500mm x L 1016mm
Color	Standard White
Mounting Options	Welded Feet
Valve	Ideal TRV Angled Valve White
Lead Time	48-72 hours
BTU value of this selection is: <span style="float: right;">i</span>	
BTU:3828	
Watts:1122	
Not sure?	<a href="#">Check BTU</a>
Total price:	<a href="#">Add to Basket</a> <a href="#">Add to Wishlist</a>

- 1 Calculate the heat output you need for your room, using our **online BTU (Heat Output) Calculator** or check with your installer, remember you may need more than one radiator to heat your room.
- 2 Use the tables on **pages 130-137** to find the best size to suit your space and heat output you need; if you cannot get the right size and output combination from a 2 column radiator try an alternative height or column (depth) option.
- 3 Choose the style of mounting option you want; for Ancona stock white & Feature Finishes standard wall brackets are included in the radiator price, for Bare Metal Lacquer Ancona stock universal wall brackets only are included in the price
- 4 If selecting cast feet or slip on welded feet there is an additional cost, see right for cast feet and slip on welded feet kits and **page 137** for bare metal lacquer slip on welded feet pricing tables.

If you need an alternative size, there are thousands of other sizes we can make to order from the full Ancona range which can be found on **pages 140-145**



# Ancona® Stock White & Feature Finishes Mounting Options

**Mounting Options for Ancona Stock in White & Feature Finishes, (Bare Metal Lacquer mounting options can be found on page 137)**

Once you have chosen your radiator size simply choose your preferred mounting option; standard wall brackets are included in the radiator price. Cast feet and slip on welded feet are an additional cost, see pricing tables below.

We will supply the correct number of brackets and wall ties with each order; prices for extra brackets / feet and wall ties are available on request, please call **01342 302250**.

Note: Ancona's over 40 sections will incur a £35 joining charge, please see bottom of this page for more information

Please specify your preferred mounting option at time of order (remember cast feet and slip on welded feet are not included in the radiator price)

Note: Ancona's must be a minimum of 100mm from the floor for all mounting options

## Wall mounting options included in radiator price

### Standard wall brackets

Supplied as standard with every Ancona order unless an alternative is specified.

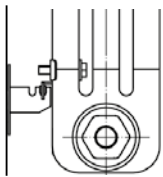

Pipe centres from wall:  
 2 column = 64mm - 74mm  
 3 column = 82mm - 92mm  
 4 column = 102mm - 112mm

### Wall ties



adjustable from 32mm to 42mm

## Optional cast feet kit prices (includes wall ties)

Section & Column Range	No. of Feet	Model	White Ex VAT	White Inc VAT	Feature Finishes Ex VAT	Feature Finishes Inc VAT
DELIVERY TIMES			48-72 HOURS		UP TO 3 WEEKS	
2-20 Sections / 2-4 Columns	2	PPANCSCFKIT2	£60.00	£72.00	£80.00	£96.00
21-30 Sections / 2-4 Columns	3	PPANCSCFKIT3	£90.00	£108.00	£120.00	£144.00
31-40 Sections / 2-4 Columns	4	PPANCSCFKIT4	£120.00	£144.00	£160.00	£192.00

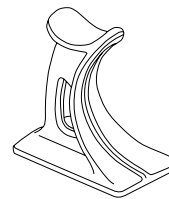

100

Pipe centres from wall:  
 2 column = 64mm - 74mm  
 3 column = 82mm - 92mm  
 4 column = 102mm - 112mm

Note: Please remember to add 100mm to the height of the Ancona section you have chosen if you are using cast feet.

## Optional slip on welded feet kit prices (includes wall ties)

Sections	No. of Feet	Model	White Ex VAT	White Inc VAT	Feature Finishes Ex VAT	Feature Finishes Inc VAT
DELIVERY TIMES			48-72 HOURS		UP TO 3 WEEKS	
Up to 20 Sections	2	PPANCSSOFKIT2	£86.00	£103.20	£116.00	£139.20
21-39 (odd number of sections)	3	PPANCSSOFKIT3	£129.00	£154.80	£174.00	£208.80
22-40 (even number of sections)	4	PPANCSSOFKIT4	£172.00	£206.40	£232.00	£278.40

100

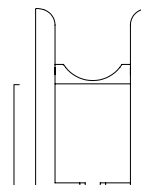

Pipe centres from wall:  
 2 column = 64mm - 74mm  
 3 column = 82mm - 92mm  
 4 column = 102mm - 112mm

Note: Please remember to add 100mm to the height of the Ancona section you have chosen if you are using slip on welded feet.

## Nylon Spanner

The perfect tool for tightening Ancona Bushes and air vents. An exact fit, this robust nylon spanner reduces the risk of damaging your radiator with inappropriate metal tools.

Description	Model	Price Ex VAT	Price Ex VAT
DELIVERY TIMES		48-72 HOURS	
Nylon Spanner	MCSPANNER	£11.00	£13.20



## Helpful notes & advice

Please call us on **01342 302250** if you need any further information or help with specifying your Ancona.

Due to transport and handling restrictions, Stock Ancona's are supplied pre-assembled up to a maximum of 40 sections. For radiators outside these parameters there is an additional joining charge, please consult Customer Services to discuss alternative requirements. All Ancona's come supplied as a finished radiator with ½" B.O.E. (Bottom Opposite End) connections as standard.

**A nominal £5 charge for postage and packing will be applied to any orders under £50 in value.**



# 1800mm High

Width (mm)	Sections	Model	Watts At 50°C	Btu's At 50°C	White Ex VAT	White Inc VAT	Feature Finishes Ex VAT	Feature Finishes Inc VAT
DELIVERY TIMES					48-72 HOURS		UP TO 3 WEEKS	
161	3	ANCS2C18X3	372	1269	<b>£166.17</b>	<b>£199.40</b>	£247.89	£297.47
206	4	ANCS2C18X4	496	1692	<b>£221.56</b>	<b>£265.87</b>	£330.52	£396.62
251	5	ANCS2C18X5	620	2115	<b>£276.95</b>	<b>£332.34</b>	£413.15	£495.78
296	6	ANCS2C18X6	744	2539	<b>£332.34</b>	<b>£398.81</b>	£495.78	£594.94
341	7	ANCS2C18X7	868	2962	<b>£387.73</b>	<b>£465.28</b>	£578.41	£694.09
386	8	ANCS2C18X8	992	3385	<b>£443.12</b>	<b>£531.74</b>	£661.04	£793.25
431	9	ANCS2C18X9	1116	3808	<b>£498.51</b>	<b>£598.21</b>	£743.67	£892.40
476	10	ANCS2C18X10	1240	4231	<b>£553.90</b>	<b>£664.68</b>	£826.30	£991.56
521	11	ANCS2C18X11	1364	4654	<b>£609.29</b>	<b>£731.15</b>	£908.93	£1,090.72
566	12	ANCS2C18X12	1488	5077	<b>£664.68</b>	<b>£797.62</b>	£991.56	£1,189.87
611	13	ANCS2C18X13	1612	5500	<b>£720.07</b>	<b>£864.08</b>	£1,074.19	£1,289.03
656	14	ANCS2C18X14	1736	5923	<b>£775.46</b>	<b>£930.55</b>	£1,156.82	£1,388.18
701	15	ANCS2C18X15	1860	6346	<b>£830.85</b>	<b>£997.02</b>	£1,239.45	£1,487.34
746	16	ANCS2C18X16	1984	6769	<b>£886.24</b>	<b>£1,063.49</b>	£1,322.08	£1,586.50
791	17	ANCS2C18X17	2108	7192	<b>£941.63</b>	<b>£1,129.96</b>	£1,404.71	£1,685.65
836	18	ANCS2C18X18	2232	7616	<b>£997.02</b>	<b>£1,196.42</b>	£1,487.34	£1,784.81
881	19	ANCS2C18X19	2356	8039	<b>£1,052.41</b>	<b>£1,262.89</b>	£1,569.97	£1,883.96
926	20	ANCS2C18X20	2480	8462	<b>£1,107.80</b>	<b>£1,329.36</b>	£1,652.60	£1,983.12

Widths include measurement for bushes.

Please note due to manufacturing tolerances widths shown may vary by +/- 2mm.

## Wall mounting options included in radiator price

### Standard wall brackets

These will always be supplied with every Ancona order unless an alternative is specified at time of order

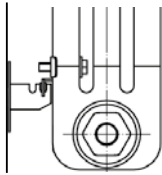

Pipe centres from wall:

2 column = 64mm - 74mm

3 column = 82mm - 92mm

4 column = 102mm - 112mm

### Wall ties



adjustable from 32 to 42mm

## Optional cast feet kit prices (includes wall ties)

Section & Column Range	No. of Feet	Model	White Ex VAT	White Inc VAT	Feature Finishes Ex VAT	Feature Finishes Inc VAT
DELIVERY TIMES			48-72 HOURS		UP TO 3 WEEKS	
2-20 Sections / 2-4 Columns	2	PPANCSCFKIT2	<b>£60.00</b>	<b>£72.00</b>	£80.00	£96.00
21-30 Sections / 2-4 Columns	3	PPANCSCFKIT3	<b>£90.00</b>	<b>£108.00</b>	£120.00	£144.00
31-40 Sections / 2-4 Columns	4	PPANCSCFKIT4	<b>£120.00</b>	<b>£144.00</b>	£160.00	£192.00

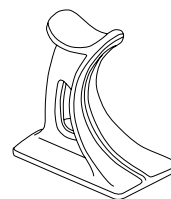

100

Pipe centres from wall:

2 column = 64mm - 74mm

3 column = 82mm - 92mm

4 column = 102mm - 112mm

Note: Please remember to add 100mm to the height of the Ancona section you have chosen if you are using cast feet.

## Optional Slip on welded feet kit prices (includes wall ties)

Sections	No. of Feet	Model	White Ex VAT	White Inc VAT	Feature Finishes Ex VAT	Feature Finishes Inc VAT
DELIVERY TIMES			48-72 HOURS		UP TO 3 WEEKS	
Up to 20 Sections	2	PPANCSSOFKIT2	<b>£86.00</b>	<b>£103.20</b>	£116.00	£139.20
21-39 (odd number of sections)	3	PPANCSSOFKIT3	<b>£129.00</b>	<b>£154.80</b>	£174.00	£208.80
22-40 (even number of sections)	4	PPANCSSOFKIT4	<b>£172.00</b>	<b>£206.40</b>	£232.00	£278.40

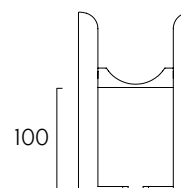

100

Pipe centres from wall:

2 column = 64mm - 74mm

3 column = 82mm - 92mm

4 column = 102mm - 112mm

Note: Please remember to add 100mm to the height of the Ancona section you have chosen if you are using slip on welded feet.

## Feature Finishes

Please call customer services for sample swatches.

New

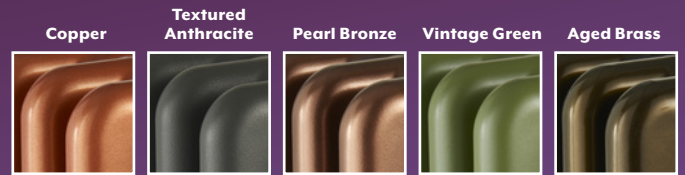

## Mounting options for stock sizes

Once you have chosen your radiator size, simply choose your preferred mounting option; standard wall brackets are included in the radiator price.

## Floor mounting options

Cast feet and slip on welded feet are an additional cost, see pricing tables below.

We will supply the correct number of brackets and wall ties with each order; prices for extra brackets / feet and wall ties are available on request, please call 01342 302250. Ancona's must be a minimum of 100mm from the floor for all mounting options.

Note: Ancona's over 40 sections will incur a £35 joining charge, please see bottom of page 129 for more information.









# Ancona<sup>®</sup> Bare Metal Lacquer pages 16-17

High quality Italian design & manufacture.  
Steel multi column (2, 3 and 4 column options)  
45mm sections.  
CE/UKCA approved & certified to BS EN442.

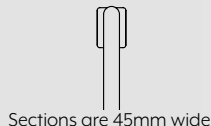

Bare Metal Lacquer as standard  
Tinted Lacquers Copper and Brass

**Bare Metal Lacquer: 48-72 Hours**

Tinted Lacquers (Copper and Brass): Up to 3 weeks

**Vintage TRV & Pipe Covers**

**SAVE £45\***  
WHEN YOU BUY OUR VINTAGE TRV & PIPE COVERS WITH ANY ANCONA<sup>®</sup> PURCHASE QUOTING PROMOV2 AT TIME OF ORDER.

For all Vintage TRV finishes.

All prices include universal wall brackets (optional slip on feet shown page 137).  
The radiators widths include bushes.  
Pipe centres left to right = width + valves.

This finish highlights the raw basic steel product showcasing the manufacturing marks created by the processes of welding and sanding to deliver an industrial look. Each radiator will be unique, with the random position of the weld lines on the column tubes and the level of the final sanding. The clear lacquer allows these characteristics to be the hero and maintains the natural steel finish. Please **see page 137** (right) for examples of weld lines and sanding marking. Our new tinted lacquers add an extra dimension whilst retaining the individual nature of the raw finish marks.

## 2 Column - 1800mm High

Additional surcharge for tinted lacquers - £17.00 (Ex VAT) £20.40 (Inc VAT) per individual section.

Width (mm)	Sections	Model	Watts Δt 50°C	Btu's Δt 50°C	Bare Metal Lacquer	
					Ex VAT	Inc VAT
DELIVERY TIMES						
					48-72 HOURS	
161	3	ANCS2C18X3L	372	1269	£207.72	£249.26
206	4	ANCS2C18X4L	496	1692	£276.96	£332.35
251	5	ANCS2C18X5L	620	2115	£346.20	£415.44
296	6	ANCS2C18X6L	744	2539	£415.44	£498.53
341	7	ANCS2C18X7L	868	2962	£484.68	£581.62
386	8	ANCS2C18X8L	992	3385	£553.92	£664.70
431	9	ANCS2C18X9L	1116	3808	£623.16	£747.79
476	10	ANCS2C18X10L	1240	4231	£692.40	£830.88
521	11	ANCS2C18X11L	1364	4654	£761.64	£913.97

Width (mm)	Sections	Model	Watts Δt 50°C	Btu's Δt 50°C	Bare Metal Lacquer	
					Ex VAT	Inc VAT
DELIVERY TIMES						
					48-72 HOURS	
566	12	ANCS2C18X12L	1488	5077	£830.88	£997.06
611	13	ANCS2C18X13L	1612	5500	£900.12	£1,080.14
656	14	ANCS2C18X14L	1736	5923	£969.36	£1,163.23
701	15	ANCS2C18X15L	1860	6346	£1,038.60	£1,246.32
746	16	ANCS2C18X16L	1984	6769	£1,107.84	£1,329.41
791	17	ANCS2C18X17L	2108	7192	£1,177.08	£1,412.50
836	18	ANCS2C18X18L	2232	7616	£1,246.32	£1,495.58
881	19	ANCS2C18X19L	2356	8039	£1,315.56	£1,578.67
926	20	ANCS2C18X20L	2480	8462	£1,384.80	£1,661.76

2 Column - 65mm



3 Column - 101mm

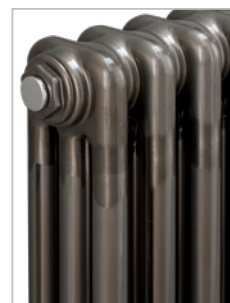

4 Column - 139mm



Sections are 45mm wide

Widths include measurement for bushes. Please note due to manufacturing tolerances widths shown may vary by +/- 2mm.

## 3 Column - 500mm High

Additional surcharge for tinted lacquers - £11.00 (Ex VAT) £13.20 (Inc VAT) per individual section.

Width (mm)	Sections	Model	Watts Δt 50°C	Btu's Δt 50°C	Bare Metal Lacquer	
					Ex VAT	Inc VAT
DELIVERY TIMES						
					48-72 HOURS	
161	3	ANCS3C50X3L	153	522	£112.98	£135.58
206	4	ANCS3C50X4L	204	696	£150.64	£180.77
251	5	ANCS3C50X5L	255	870	£188.30	£225.96
296	6	ANCS3C50X6L	306	1044	£225.96	£271.15
341	7	ANCS3C50X7L	357	1218	£263.62	£316.34
386	8	ANCS3C50X8L	408	1392	£301.28	£361.54
431	9	ANCS3C50X9L	459	1566	£338.94	£406.73
476	10	ANCS3C50X10L	510	1740	£376.60	£451.92
521	11	ANCS3C50X11L	561	1914	£414.26	£497.11
566	12	ANCS3C50X12L	612	2088	£451.92	£542.30
611	13	ANCS3C50X13L	663	2262	£489.58	£587.50
656	14	ANCS3C50X14L	714	2436	£527.24	£632.69
701	15	ANCS3C50X15L	765	2610	£564.90	£677.88
746	16	ANCS3C50X16L	816	2784	£602.56	£723.07
791	17	ANCS3C50X17L	867	2958	£640.22	£768.26
836	18	ANCS3C50X18L	918	3132	£677.88	£813.46
881	19	ANCS3C50X19L	969	3306	£715.54	£858.65
926	20	ANCS3C50X20L	1020	3480	£753.20	£903.84
971	21	ANCS3C50X21L	1071	3654	£790.86	£949.03

Width (mm)	Sections	Model	Watts Δt 50°C	Btu's Δt 50°C	Bare Metal Lacquer	
					Ex VAT	Inc VAT
DELIVERY TIMES						
					48-72 HOURS	
1016	22	ANCS3C50X22L	1122	3828	£828.52	£994.22
1061	23	ANCS3C50X23L	1173	4002	£866.18	£1,039.42
1106	24	ANCS3C50X24L	1224	4176	£903.84	£1,084.61
1151	25	ANCS3C50X25L	1275	4350	£941.50	£1,129.80
1196	26	ANCS3C50X26L	1326	4524	£979.16	£1,174.99
1241	27	ANCS3C50X27L	1377	4698	£1,016.82	£1,220.18
1286	28	ANCS3C50X28L	1428	4872	£1,054.48	£1,265.38
1331	29	ANCS3C50X29L	1479	5046	£1,092.14	£1,310.57
1376	30	ANCS3C50X30L	1530	5220	£1,129.80	£1,355.76
1421	31	ANCS3C50X31L	1581	5394	£1,167.46	£1,400.95
1466	32	ANCS3C50X32L	1632	5568	£1,205.12	£1,446.14
1511	33	ANCS3C50X33L	1683	5742	£1,242.78	£1,491.34
1556	34	ANCS3C50X34L	1734	5916	£1,280.44	£1,536.53
1601	35	ANCS3C50X35L	1785	6090	£1,318.10	£1,581.72
1646	36	ANCS3C50X36L	1836	6264	£1,355.76	£1,626.91
1691	37	ANCS3C50X37L	1887	6438	£1,393.42	£1,672.10
1736	38	ANCS3C50X38L	1938	6612	£1,431.08	£1,717.30
1781	39	ANCS3C50X39L	1989	6786	£1,468.74	£1,762.49
1826	40	ANCS3C50X40L	2040	6960	£1,506.40	£1,807.68

Widths include measurement for bushes. Please note due to manufacturing tolerances widths shown may vary by +/- 2mm.





# Ancona® Made to Order shown on pages 18-29

High quality Italian design & manufacture.  
Steel multi column 45mm sections, 2-6 column options  
CE/UKCA approved & certified to BS EN442.



White RAL 9016 as standard, 188 RAL colours and 31 Special Finishes  
Please call **01342 302250** for a RAL or Special Finish chart

Made to Order: Up to 4 weeks White & Colours  
Up to 6 weeks Bare Metal Lacquer.



**Vintage TRV & Pipe Covers**

**SAVE £45\***

WHEN YOU BUY OUR VINTAGE TRV & PIPE COVERS WITH ANY ANCONA® PURCHASE QUOTING PROMOV2 AT TIME OF ORDER.

For all Vintage TRV finishes.

Create a radiator that matches your exact requirements with thousands of sizes, plus a choice of 188 RAL colours and 31 special finishes available, including a bare metal lacquer finish.

## Choose your radiator using our online radiator builder

Once you know your outputs use our online radiator builder to select the best solution for your room. It will take you through the process quickly and easily and allows you to save your ideas to your own Wish List. Go to our **NEW** website [theradiatorcompany.co.uk](http://theradiatorcompany.co.uk)

It is vital to know the correct heat output you need to keep your room warm, use our online BTU (heat output) calculator to get a guide to your requirements which you can then check with your installer.

**Edit Build**

**Build Summary**

Radiator Columns: **4**

Height & Length: **H 600mm x L 971mm**

Colour: **RAL8024-Beige Brown**

Mounting Options: **Cast Feet (+100mm to the Height)**

Valve: **Vintage XL TRV Angled Valves Antique Copper**

Lead Time: **4 weeks**

BTU value of this selection is:

**BTU: 5670**

**Watts: 1659**

Last checked BTU measurement:

**BTU: 6375 - 7650**

**WATTS: 1875 - 2250**

Not sure? [Check BTU](#)

Total price: [Add to Basket](#) [Add to Wish List](#)

Once you know your outputs you can use the brochure to specify your radiator by following these steps (or call our Customer Services team on 01342 302250 who will help you size your radiator).

- Note the space you have in mind for the radiator(s) you need; vertical or horizontal, length, height & depth
- Select a column option and height that fits your space; Calculate the number of sections you need by dividing the required BTU (Watt) output with the output per section; e.g 4142 BTUs divided by 205 = 20 sections, based on 3 column, 600mm high sections (always round up to the next whole number of sections).
- If the use of this section size does not work in the available space, try a different column option or if possible a different height.
- Once you have calculated the best number and size of sections, select the best mounting option. Wall hung options (standard wall brackets) are included in your radiator price. Cast feet or welded feet are an additional cost, see kit prices on page 143. Choose your colour from over 200 colours and special finishes; white RAL 9016 or 9010 are our standard finishes.
- Work out the price of your radiator; e.g 3 column 600mm high, white, 20 sections x £36.52 = £730.32 + welded feet kit price £136.80 = £867.20 (inc VAT).
- Place your order with your local Merchant using the Sectional Model Code x No. of Sections needed, noting the Mounting Option and the name and number of the colour you have chosen; e.g ANCO360W x 20 sections, RAL 9016 Traffic white, with welded feet.
- If you have chosen a colour use the colour reference 'R' instead of 'W' and list the colour number and name.

All prices and outputs are given per section in the tables on pages 140-141. Price per section includes plugs, bushes and diverter. Mounting options must be selected separately, these will include the air vent and appropriate number of wall ties.

\*Saving based on the value of individual items when bought separately. Order any of our selected valves and matching pipe covers at the same time as your radiator.

# Ancona® Made to Order - Colours & Special Finishes

The Ancona® made to order range is available in 188 RAL colours including our standard white RAL 9016, a bright porcelain white. As an alternative, RAL 9010 Pure White, a soft creamier white can be specified at the standard white price. We also offer 31 special finishes including Gun Metal Grey, Textured White and Ivory, Mottled, Metallics, Golds & a Bare Metal Lacquer finish. Please call **01342 302250** for a RAL chart & Special Finish chart.



## 188 RAL Colours

Match your room style by selecting from a full rainbow of 188 RAL colours. Use either contrasting colours to create a bold statement or sympathetic colours so your Ancona® blends in to your wall.



## 31 Special Finishes including a Bare Metal Lacquer finish

There are 31 classic colours to choose from including: metallics, mottled, textured effects, as well as bare metal lacque finish, for a Special Finish chart please call our Customer Service team on **01342 302250**.



Textured Black Matt



Textured Stone



Mottled Silver



Gun Metal Grey



Mottled Copper



Pearl White



Black Sparkle



Bare Metal Lacquer

## Helpful notes & advice

Please call us on **01342 302250** if you need any further information or help with specifying your Ancona®.

Ancona® sections are 45mm wide, therefore the total radiator length is; "no. of Sections x 45mm + 26mm for bushes + valves" (*Please note due to manufacturing tolerances widths shown may vary by +/- 2mm*). When considering the height of your radiator remember that your mounting option will affect the overall height of your radiator. Made To Order Anconas® are supplied factory assembled up to a maximum of 40 sections. For radiators outside these parameters there is an additional joining charge please consult Customer Services to discuss alternative requirements.

# Ancona® Made to Order shown on pages 18-29

Specify your radiator online; Use our **Online Radiator Builder** to quickly and easily specify your radiator.

Go to our website **theradiatorcompany.co.uk**.

Use these tables to specify your radiator by following these steps;

- 1 Calculate the heat output you need for your room, using our online **BTU (Heat Output) Calculator** or check with your installer, remember you may need more than one radiator to heat your room.
- 2 Use the tables below & right to find the best size to suit your space and heat output you need; if you cannot get the right size & output combination from a 2 column radiator try an alternative height or column (depth) option, see page 138 for more details on how to size your radiator.
- 3 Choose the style of mounting option you want; standard wall brackets are included in the radiator price (universal wall brackets for lacquer finishes). If selecting cast feet or welded feet there is an additional cost, see pricing tables on page 143.
- 4 Choose your colour from a choice of 188 RAL colours and 31 special finishes including bare metal lacquer, see page 139.

All prices and outputs are given per section in the tables below. Price per section includes plugs, bushes, diverter, wall brackets and wall ties.

Alternative mounting options must be selected separately, these will include the air vent and appropriate number of wall ties.

Made To Order Anconas® are supplied factory assembled up to a maximum of 40 sections. For radiators outside these parameters, there is an additional joining charge please consult Customer Services to discuss alternative requirements.

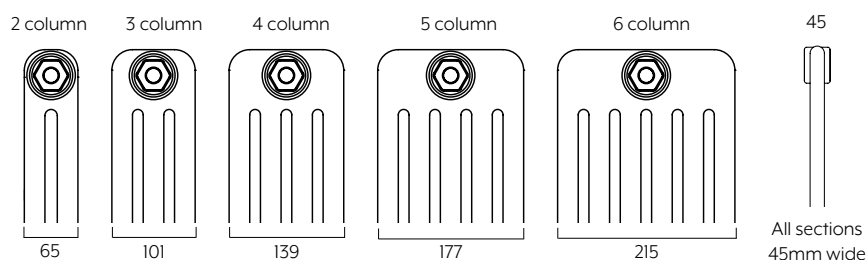

Pipe Centres for all White & Colour Anconas with Cast Feet, Welded Feet or Wall Brackets are;	
Pipe centres left to right = number of sections x 45mm plus 26mm (13mm each) for bushes plus valves. <i>Note due to manufacturing tolerances widths may vary by +/- 2mm.</i>	
Pipe centres from wall (based on adjustable wall ties)	2 Column = 64mm to 74mm 3 Column = 82mm to 92mm 4 Column = 102mm to 112mm 5 Column = 120mm to 130mm 6 Column = 140mm to 150mm

## Sections

### 2 Column - 65mm Deep

Height (mm)	Width (mm)	Model	Watts Δt 50°C	Btu's Δt 50°C	White Ex VAT	White Inc VAT	Colours & Lacquer Ex VAT	Colours & Lacquer Inc VAT
							Ex VAT	Inc VAT
DELIVERY TIMES					UP TO 4 WEEKS		4-6 WEEKS	
195	45	ANCO2C19	14	48	£22.91	£27.49	£28.64	£34.37
300	45	ANCO2C30	23	78	£24.20	£29.04	£30.25	£36.30
350	45	ANCO2C35	26	89	£24.89	£29.87	£31.11	£37.33
365	45	ANCO2C36	27	92	£25.00	£30.00	£31.25	£37.50
400	45	ANCO2C40	30	102	£25.19	£30.23	£31.49	£37.79
450	45	ANCO2C45	33	113	£25.86	£31.03	£32.33	£38.80
500	45	ANCO2C50	36	123	£26.06	£31.27	£32.58	£39.10
550	45	ANCO2C55	39	133	£26.35	£31.62	£32.94	£39.53
565	45	ANCO2C56	40	136	£26.41	£31.69	£33.01	£39.61
600	45	ANCO2C60	43	147	£26.59	£31.91	£33.24	£39.89
650	45	ANCO2C65	46	157	£26.64	£31.97	£33.30	£39.96
665	45	ANCO2C66	47	160	£27.14	£32.57	£33.93	£40.72
685	45	ANCO2C68	48	164	£27.46	£32.95	£34.33	£41.20
750	45	ANCO2C75	52	177	£27.61	£33.13	£34.51	£41.41
765	45	ANCO2C76	53	181	£29.54	£35.45	£36.93	£44.32
865	45	ANCO2C86	60	205	£30.83	£37.00	£38.54	£46.25
885	45	ANCO2C88	61	208	£31.02	£37.22	£38.78	£46.54
900	45	ANCO2C90	62	212	£31.33	£37.60	£39.16	£46.99
1000	45	ANCO2C10	69	235	£32.49	£38.99	£40.61	£48.73
1200	45	ANCO2C12	82	280	£37.96	£45.55	£47.45	£56.94
1500	45	ANCO2C15	103	351	£45.75	£54.90	£57.19	£68.63
1800	45	ANCO2C18	124	423	£55.39	£66.47	£69.24	£83.09
2000	45	ANCO2C20	139	474	£62.84	£75.41	£78.55	£94.26
2200	45	ANCO2C22	154	525	£68.79	£82.55	£85.99	£103.19
2500	45	ANCO2C25	177	604	£78.75	£94.50	£98.44	£118.13

### 3 Column - 101mm Deep

Height (mm)	Width (mm)	Model	Watts Δt 50°C	Btu's Δt 50°C	White Ex VAT	White Inc VAT	Colours & Lacquer Ex VAT	Colours & Lacquer Inc VAT
							Ex VAT	Inc VAT
DELIVERY TIMES					UP TO 4 WEEKS		4-6 WEEKS	
195	45	ANCO3C19	20	68	£24.59	£29.51	£30.74	£36.89
300	45	ANCO3C30	32	109	£26.55	£31.86	£33.19	£39.83
350	45	ANCO3C35	37	126	£27.71	£33.25	£34.64	£41.57
365	45	ANCO3C36	38	130	£28.01	£33.61	£35.01	£42.01
400	45	ANCO3C40	42	143	£28.69	£34.43	£35.86	£43.03
450	45	ANCO3C45	46	157	£29.54	£35.45	£36.93	£44.32
500	45	ANCO3C50	51	174	£30.13	£36.16	£37.66	£45.19
550	45	ANCO3C55	55	188	£30.24	£36.29	£37.80	£45.36
565	45	ANCO3C56	57	194	£30.37	£36.44	£37.96	£45.55
600	45	ANCO3C60	60	205	£30.43	£36.52	£38.04	£45.65
650	45	ANCO3C65	65	222	£31.65	£37.98	£39.56	£47.47
665	45	ANCO3C66	66	225	£32.13	£38.56	£40.16	£48.19
685	45	ANCO3C68	68	232	£32.82	£39.38	£41.03	£49.24
750	45	ANCO3C75	74	252	£33.06	£39.67	£41.33	£49.60
765	45	ANCO3C76	75	256	£36.29	£43.55	£45.36	£54.43
865	45	ANCO3C86	84	287	£36.50	£43.80	£45.63	£54.76
885	45	ANCO3C88	86	293	£36.98	£44.38	£46.23	£55.48
900	45	ANCO3C90	87	297	£37.28	£44.74	£46.60	£55.92
1000	45	ANCO3C10	96	328	£39.13	£46.96	£48.91	£58.69
1200	45	ANCO3C12	114	389	£50.06	£60.07	£62.58	£75.10
1500	45	ANCO3C15	141	481	£66.84	£80.21	£83.55	£100.26
1800	45	ANCO3C18	168	573	£72.47	£86.96	£90.59	£108.71
2000	45	ANCO3C20	187	638	£86.74	£104.09	£108.43	£130.12
2200	45	ANCO3C22	205	699	£98.16	£117.79	£122.70	£147.24
2500	45	ANCO3C25	233	795	£106.63	£127.96	£133.29	£159.95



# Ancona® Made to Order - Wall Brackets

Once you have chosen your radiator size you can choose any one of our 3 mounting options & specify at time of order (fittings are available to order with a corresponding radiator only).

Standard wall brackets are included in your radiator price. The correct number of brackets and wall ties will be supplied with each order; prices for extra wall brackets and wall ties are available on request, please call **01342 302250**.

Technical & pipe centre information of each mounting option is shown below / right.

Please note: Anconas® in a bare metal lacquer finish are only available to be mounted with universal wall brackets or welded feet.



\*PPANCOWNB

## Standard wall brackets technical & pipe centre information (suitable for stud walls) (appropriate for all finishes except Bare Metal Lacquer)

Can be positioned at any height (minimum height from floor 100mm); brackets are supplied with raw plugs.

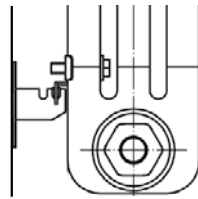

Pipe centres from wall:  
 2 column = 64mm - 74mm  
 3 column = 82mm - 92mm  
 4 column = 102mm - 112mm  
 5 column = 120mm - 130mm  
 6 column = 140mm - 150mm



Wall tie; adjustable from 32mm to 42mm



\*PPANCOWNB

## Bare metal lacquer universal wall brackets (suitable for stud walls)

Note: Ancona's with lacquer wall brackets can be positioned at any height (minimum 100mm from floor)

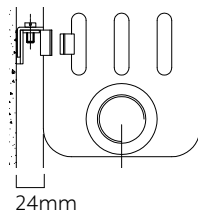

Pipe centres from wall:  
 2 column = 56mm  
 3 column = 74mm  
 4 column = 93mm  
 5 column = 112mm  
 6 column = 131mm

## Build your radiator using our online radiator builder on our new and improved website

It is vital to know the correct heat output you need to keep your room warm, use our **online BTU (heat output) calculator** to get a guide to your requirements which you can then check with your installer.

Once you know your outputs use our **online radiator builder** to select the best solution for your room. It will take you through the process quickly and easily and allows you to save your ideas to your own Wish List. Please go to our website **theradiatorcompany.co.uk**

## Optional Solid Brass Wall Ties & Airvents

These solid brass wall ties provide a stylish finishing touch to any Ancona® radiator; select to match your valves. Available as a kit including matching airvent in Antique Brass, Chrome, Polished Brass and Brushed Nickel.

Please note that these wall ties and airvents are an optional extra and do not come as standard with your Ancona® radiator.

Description	Model	Number of Wall Ties	Number of Airvents	Number of Blank Plugs	Price Ex VAT	Price Inc VAT
DELIVERY TIMES					<b>48-72 HOURS</b>	
Single Wall Tie	PPANWT	1	N/A	N/A	<b>£68.00</b>	<b>£81.60</b>
Single Airvent & Blank Plug	PPLAVBP	N/A	1	1	<b>£18.00</b>	<b>£21.60</b>
Wall Tie, Airvent & Blank Plug Kit	PPANWTAVKIT2	2	1	1	<b>£149.00</b>	<b>£178.80</b>
Wall Tie, Airvent & Blank Plug Kit	PPANWTAVKIT3	3	1	1	<b>£211.00</b>	<b>£253.20</b>
Wall Tie, Airvent & Blank Plug Kit	PPANWTAVKIT4	4	1	1	<b>£276.00</b>	<b>£331.20</b>
Wall Tie, Airvent & Blank Plug Kit	PPANWTAVKIT5	5	1	1	<b>£340.00</b>	<b>£408.00</b>

Antique Brass

Chrome

Polished Brass

Brushed Nickel

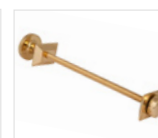
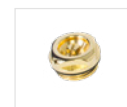
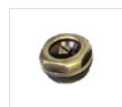

Please specify your finish at time of order.

# Ancona® Made to Order - Floor Mounting Options

Once you have chosen your radiator size you can choose to have your Ancona® floor mounted by selecting either Welded or Cast feet (fittings are available to order with a corresponding radiator only).

**Please note; Welded feet and Cast Feet are an additional cost to your radiator price.**

The correct number of wall ties will be supplied with each order; prices for extra cast feet and wall ties are available on request, please call **01342 302250**.

Please specify your preferred floor mounting option & kit number at time of order.

Technical & pipe centre information of each mounting option is shown below.

## Cast feet kit prices

**Note: please remember to add 100mm to the height of the Ancona® section you have chosen if you are using cast feet.**

Section & Column Range	No. of Feet	Model	White Ex VAT	White Inc VAT	Colours Ex VAT	Colours Inc VAT
DELIVERY TIMES			UP TO 4 WEEKS		UP TO 4 WEEKS	
2-20 Sections / 2-6 Columns	2	PPANCOCFKIT2	£60.00	£72.00	£75.00	£90.00
21-30 Sections / 2-6 Columns	3	PPANCOCFKIT3	£90.00	£108.00	£112.50	£135.00
31-40 Sections / 2-6 Columns	4	PPANCOCFKIT4	£120.00	£144.00	£150.00	£180.00

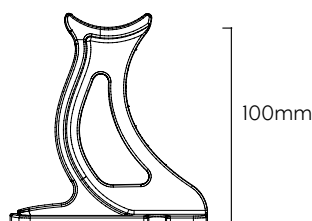

## Cast Feet pipe centres



Pipe centres from wall:

- 2 column = 64mm - 74mm
- 3 column = 82mm - 92mm
- 4 column = 102mm - 112mm
- 5 column = 120mm - 130mm
- 6 column = 140mm - 150mm



Wall tie; adjustable from 32mm to 42mm

*Please note: cast feet are not available for bare metal lacquer finishes*

\*PPANCOCFK

## Welded feet kit prices

**Note: Please remember to add 97mm to the height of the Ancona® section you have chosen if you are using welded feet.**

Sections	No. of Feet	Model	White Ex VAT	White Inc VAT	Colours & Lacquer Ex VAT	Colours & Lacquer Inc VAT
DELIVERY TIMES			UP TO 4 WEEKS		4-6 WEEKS	
Up to 20 Sections	2	PPANCOWFKIT2	£114.00	£136.80	£142.50	£171.00
21-39 (odd number of sections)	3	PPANCOWFKIT3	£171.00	£205.20	£213.75	£256.50
22-40 (even number of sections)	4	PPANCOWFKIT4	£228.00	£273.60	£285.00	£342.00

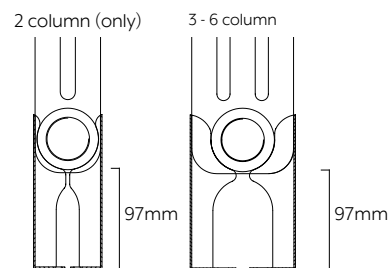

## White & colour welded feet pipe centres

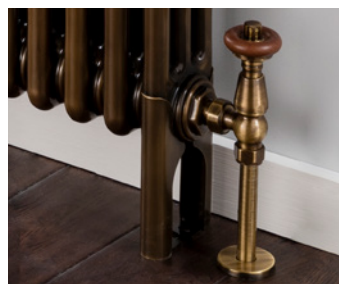

Pipe centres from wall:

- 2 column = 64mm - 74mm
- 3 column = 82mm - 92mm
- 4 column = 102mm - 112mm
- 5 column = 120mm - 130mm
- 6 column = 140mm - 150mm

\*PPANCOWF

## Bare metal lacquer welded feet pipe centres

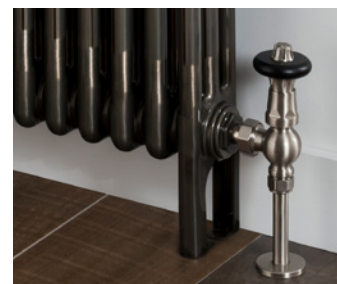

Pipe centres from wall:

- 2 column = 56mm
- 3 column = 74mm
- 4 column = 93mm
- 5 column = 112mm
- 6 column = 131mm

\*PPANCOWF

Anconas® with welded feet are supplied with the correct number of feet (see above); additional welded feet cannot be ordered.

# Ancona® Bench Seat Horizontal page 26

High quality Italian design and manufacture  
Steel multi column supplied with a wooden seat  
CE/UKCA approved & certified to BS EN442



White RAL 9016 as standard, 188 RAL colours and 30 Special Finishes  
Please call **01342 302250** for a RAL or Special Finish chart

Made to Order: Up to 4 weeks White & Colours



**Vintage TRV & Pipe Covers** 

**SAVE £45\***  
WHEN YOU BUY OUR VINTAGE TRV & PIPE COVERS WITH ANY ANCONA® PURCHASE QUOTING PROMOV2 AT TIME OF ORDER.

For all Vintage TRV finishes.

Height A (mm)	Radiator Width B (mm)	Bench Seat Width C (mm)	Columns	Sections	Model	Watts Δt 50°C	Btu's Δt 50°C	White Ex VAT	White Inc VAT	Colours Ex VAT	Colours Inc VAT	DELIVERY TIMES		
												UP TO 4 WEEKS	UP TO 4 WEEKS	UP TO 4 WEEKS
460	502	650	6	4	ANCB4S4665	383	1307	£1,613.00	£1,935.60	£2,016.25	£2,419.50			
	667	815			ANCB4S4681	495	1689	£1,826.00	£2,191.20	£2,282.50	£2,739.00			
	867	1015			ANCB4S4610	628	2143	£2,064.00	£2,476.80	£2,580.00	£3,096.00			
	1202	1350			ANCB4S4613	845	2883	£2,280.00	£2,736.00	£2,850.00	£3,420.00			
	1502	1650			ANCB4S4616	1036	3535	£2,493.00	£2,991.60	£3,116.25	£3,739.50			
	1802	1950			ANCB4S4619	1226	4183	£2,659.00	£3,190.80	£3,323.75	£3,988.50			
	2002	2150			ANCB4S4621	1352	4613	£2,798.00	£3,357.60	£3,497.50	£4,197.00			
	2202	2350			ANCB4S4623	1477	5040	£3,060.00	£3,672.00	£3,825.00	£4,590.00			
	2502	2650			ANCB4S4626	1665	5681	£3,178.00	£3,813.60	£3,972.50	£4,767.00			
460	502	650	6	5	ANCB5S4665	479	1634	£1,660.00	£1,992.00	£2,075.00	£2,490.00			
	667	815			ANCB5S4681	619	2112	£1,883.00	£2,259.60	£2,353.75	£2,824.50			
	867	1015			ANCB5S4610	785	2678	£2,134.00	£2,560.80	£2,667.50	£3,201.00			
	1202	1350			ANCB5S4613	1056	3603	£2,366.00	£2,839.20	£2,957.50	£3,549.00			
	1502	1650			ANCB5S4616	1296	4422	£2,609.00	£3,130.80	£3,261.25	£3,913.50			
	1802	1950			ANCB5S4619	1533	5231	£2,726.00	£3,271.20	£3,407.50	£4,089.00			
	2002	2150			ANCB5S4621	1690	5766	£2,867.00	£3,440.40	£3,583.75	£4,300.50			
	2202	2350			ANCB5S4623	1847	6302	£3,139.00	£3,766.80	£3,923.75	£4,708.50			
	2502	2650			ANCB5S4626	2081	7100	£3,289.00	£3,946.80	£4,111.25	£4,933.50			
505	502	650	6	6	ANCB6S5065	575	1962	£1,709.00	£2,050.80	£2,136.25	£2,563.50			
	667	815			ANCB6S5081	742	2532	£1,942.00	£2,330.40	£2,427.50	£2,913.00			
	867	1015			ANCB6S5010	941	3211	£2,197.00	£2,636.40	£2,746.25	£3,295.50			
	1202	1350			ANCB6S5013	1267	4323	£2,463.00	£2,955.60	£3,078.75	£3,694.50			
	1502	1650			ANCB6S5016	1555	5306	£2,739.00	£3,286.80	£3,423.75	£4,108.50			
	1802	1950			ANCB6S5019	1839	6275	£2,880.00	£3,456.00	£3,600.00	£4,320.00			
	2002	2150			ANCB6S5021	2027	6916	£3,027.00	£3,632.40	£3,783.75	£4,540.50			
	2202	2350			ANCB6S5023	2216	7561	£3,330.00	£3,996.00	£4,162.50	£4,995.00			
	2502	2650			ANCB6S5026	2497	8520	£3,506.00	£4,207.20	£4,382.50	£5,259.00			

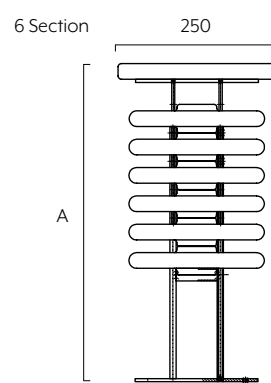
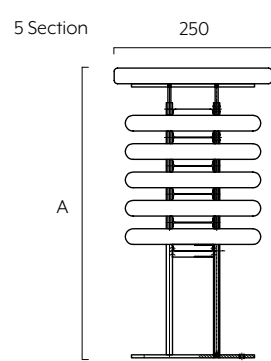
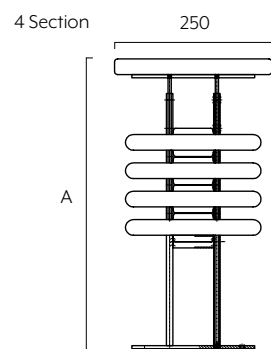

All prices shown include wooden seat.

**Please note: Bench seats over 1650mm wide will be supplied with 3 feet.**

Pipe centres = width (B) - 67mm

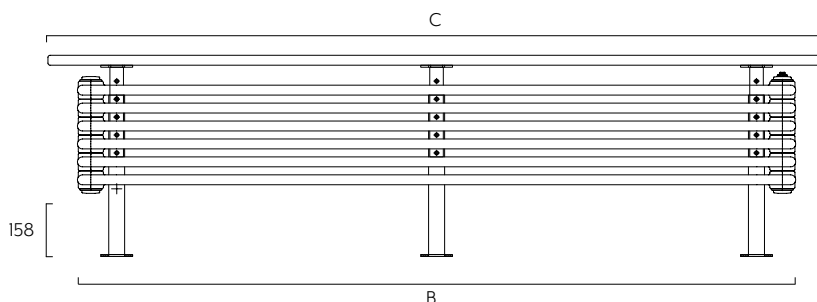

\*Saving based on the value of individual items when bought separately. Order any of our selected valves and matching pipe covers at the same time as your radiator.



# Ancona® Bench Seat Vertical page 27

High quality Italian design and manufacture  
Steel multi column supplied with a wooden seat  
CE/UKCA approved & certified to BS EN442.



White RAL 9016 as standard, 188 RAL colours and 30 Special Finishes  
Please call **01342 302250** for a RAL or Special Finish chart

Made to Order: Up to 5 weeks White & Colours



**SAVE £45\***  
WHEN YOU BUY OUR VINTAGE TRV & PIPE COVERS WITH ANY ANCONA® PURCHASE QUOTING PROMOV2 AT TIME OF ORDER.

For all Vintage TRV finishes.

Height A (mm)	Radiator Width B (mm)	Bench Seat Width C (mm)	Columns	Sections	Model	Watts Δt 50°C	Btu's Δt 50°C	White Ex VAT	White Inc VAT	Colours Ex VAT	Colours Inc VAT	DELIVERY TIMES	
												UP TO 5 WEEKS	UP TO 5 WEEKS
496	1016	1350	4	22	ANCB4C22S	926	3160	£1,203.00	£1,443.60	£1,503.75	£1,804.50	UP TO 5 WEEKS	UP TO 5 WEEKS
	1286	1650		28	ANCB4C28S	1179	4023	£1,320.00	£1,584.00	£1,650.00	£1,980.00		
	1466	1650		32	ANCB4C32S	1347	4596	£1,436.00	£1,723.20	£1,795.00	£2,154.00		
	1646	1950		36	ANCB4C36S	1516	5173	£1,514.00	£1,816.80	£1,892.50	£2,271.00		
	1736	1950		38	ANCB4C38S	1600	5459	£1,601.00	£1,921.20	£2,001.25	£2,401.50		
	2051	2150		45	ANCB4C45S	1895	6466	£1,811.00	£2,173.20	£2,263.75	£2,716.50		
	2366	2650		52	ANCB4C52S	2189	7469	£2,042.00	£2,450.40	£2,552.50	£3,063.00		
	1016	1350		5	22	ANCB5C22S	1131	3859	£1,271.00	£1,525.20	£1,588.75		
	1286	1650	28		ANCB5C28S	1439	4910	£1,404.00	£1,684.80	£1,755.00	£2,106.00		
	1466	1650	32		ANCB5C32S	1645	5613	£1,531.00	£1,837.20	£1,913.75	£2,296.50		
	1646	1950	36		ANCB5C36S	1850	6312	£1,621.00	£1,945.20	£2,026.25	£2,431.50		
	1736	1950	38		ANCB5C38S	1953	6664	£1,716.00	£2,059.20	£2,145.00	£2,574.00		
	2051	2150	45		ANCB5C45S	2313	7892	£1,946.00	£2,335.20	£2,432.50	£2,919.00		
	2366	2650	52		ANCB5C52S	2673	9120	£2,200.00	£2,640.00	£2,750.00	£3,300.00		
	1016	1350	6		22	ANCB6C22S	1335	4555	£1,353.00	£1,623.60	£1,691.25	£2,029.50	
	1286	1650		28	ANCB6C28S	1700	5800	£1,509.00	£1,810.80	£1,886.25	£2,263.50		
	1466	1650		32	ANCB6C32S	1942	6626	£1,649.00	£1,978.80	£2,061.25	£2,473.50		
	1646	1950		36	ANCB6C36S	2185	7455	£1,756.00	£2,107.20	£2,195.00	£2,634.00		
	1736	1950		38	ANCB6C38S	2307	7871	£1,855.00	£2,226.00	£2,318.75	£2,782.50		
	2051	2150		45	ANCB6C45S	2732	9322	£2,182.00	£2,618.40	£2,727.50	£3,273.00		
	2366	2650		52	ANCB6C52S	3156	10768	£2,461.00	£2,953.20	£3,076.25	£3,691.50		

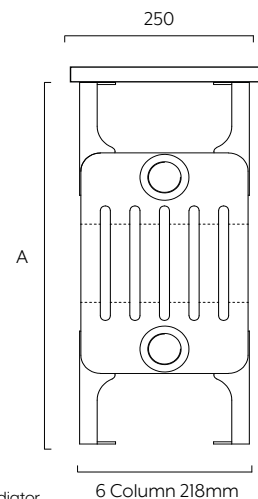
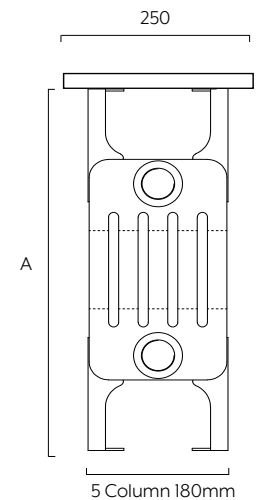
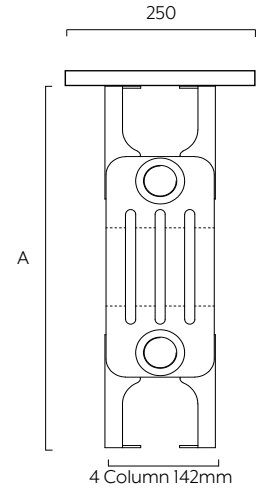

All prices shown include wooden seat. Please note height (A) does not include wooden seat.

**Please note: Bench seats 1286mm wide and over will be supplied with 4 feet.**

Pipe centres = width of radiator (B) + valves  
Due to manufacturing tolerances widths may vary by +/- 2mm.

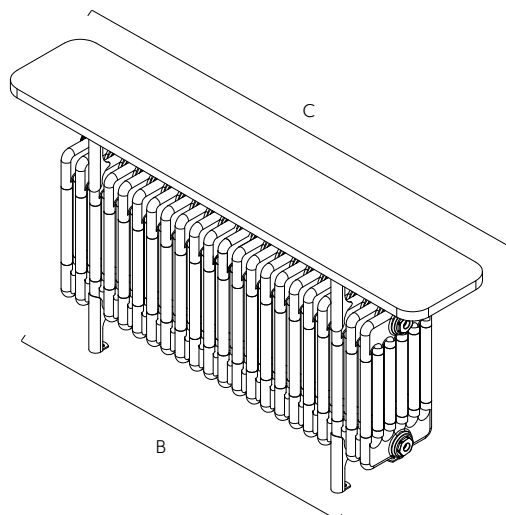
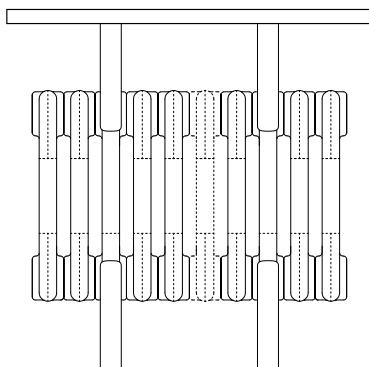

\*Saving based on the value of individual items when bought separately. Order any of our selected valves & matching pipe covers at the same time as your radiator.

# Ancona® Curved shown on page 28



High quality Italian design & manufacture

Steel Multi Column; 2, 3 & 4 column options with wall brackets or optional welded feet  
CE/UKCA approved & certified to BS EN442.

White RAL 9016 as standard, 188 RAL colours and 30 Special Finishes

Please call **01342 302250** for a RAL or Special Finish chart

Approximately 6 weeks from receipt of written sign off of technical drawings

Visit our website for further information **theradiatorcompany.co.uk**.



Our Ancona® radiators can be curved to fit bay windows and around columns.

Alternative heights are available on request, please contact us on **01342 302250** if required.

Radiators can be curved using up to 40 sections, minimum 10 sections (450mm).

As with all radiators, it is essential to know how much heat you need to keep your room comfortable, use our online Heat Output Calculator to work out how much heat you will need for your room before you size your radiator.

Curving is a precise process and as such accurate measurements and calculations must be made and checked before production can begin. Since our Ancona® Curved is made on a bespoke basis to your exact requirements, we have created an online tool to help make the process as easy as possible;

To order your curved radiator follow these simple steps;

- 1 Go to our website **theradiatorcompany.co.uk** and select the 'Curved Ancona®' in the steel multi column section, download or read the specification document which explains how to measure for your curved radiator
- 2 Use our online Curved Radiator Builder by filling in all the sections
- 3 When you have reviewed the technical specification, double-check everything is correct to see how your radiator will fit in your space
- 4 Print the technical specification and sign all pages once you are happy with the details
- 5 Use the signed specification to place your order with your Installer or local merchant

Alternatively, you can complete the Specification Instruction sheet with the dimensions of your bay or column and return it to us via email, fax or post (please see contact details below). However, this will take extra time for us to have drawings made and then sent to you for approval before any order can be placed.

**Please note; once you have signed off your drawings and ordered your curved radiator it cannot be cancelled or returned.**

Ancona® Curved 2 column (output by section)

Height (mm)	Model	Watts Δt 50°C	Btu's Δt 50°C	White Ex VAT	White Inc VAT	Colours Ex VAT	Colours Inc VAT
DELIVERY TIMES		6 WEEKS FROM SIGN OFF					
300	ANCC2C30	23	78	£50.55	£60.66	£56.60	£67.92
400	ANCC2C40	30	102	£51.54	£61.85	£57.84	£69.41
500	ANCC2C50	36	123	£52.41	£62.89	£58.93	£70.72
600	ANCC2C60	43	147	£52.94	£63.53	£59.59	£71.51
750	ANCC2C75	52	177	£53.96	£64.75	£60.86	£73.03

Internal Ancona® Curved

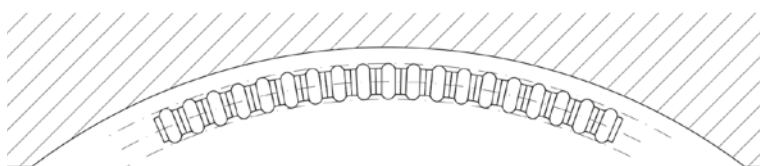

Ancona® Curved 3 column (output by section)

Height (mm)	Model	Watts Δt 50°C	Btu's Δt 50°C	White Ex VAT	White Inc VAT	Colours Ex VAT	Colours Inc VAT
DELIVERY TIMES		6 WEEKS FROM SIGN OFF					
300	ANCC3C30	32	109	£52.90	£63.48	£59.54	£71.45
400	ANCC3C40	42	143	£55.04	£66.05	£62.21	£74.65
500	ANCC3C50	51	174	£56.48	£67.78	£64.01	£76.81
600	ANCC3C60	60	205	£56.78	£68.14	£64.39	£77.27
750	ANCC3C75	74	252	£59.41	£71.29	£67.68	£81.22

## Kits for welded feet

**Note: Please remember to add 97mm to the height of the Ancona section you have chosen if you are using welded feet.**

Ancona® Curved 4 column (output by section)

Height (mm)	Model	Watts Δt 50°C	Btu's Δt 50°C	White Ex VAT	White Inc VAT	Colours Ex VAT	Colours Inc VAT
DELIVERY TIMES		6 WEEKS FROM SIGN OFF					
300	ANCC4C30	42	143	£56.37	£67.64	£63.88	£76.66
400	ANCC4C40	54	184	£57.88	£69.46	£65.76	£78.91
500	ANCC4C50	66	225	£60.19	£72.23	£68.65	£82.38
600	ANCC4C60	79	270	£63.09	£75.71	£72.28	£86.74
750	ANCC4C75	96	328	£64.04	£76.85	£73.46	£88.15

Sections	Model	No. of Feet	White Ex VAT	White Inc VAT	Colours Ex VAT	Colours Inc VAT
DELIVERY TIMES		6 WEEKS FROM SIGN OFF				
Up to 20 Sections	PPANCOWFKIT2	2	£114.00	£136.80	£142.50	£171.00
21-39 (odd number of sections)	PPANCOWFKIT3	3	£171.00	£205.20	£213.75	£256.50
22-40 (even number of sections)	PPANCOWFKIT4	4	£228.00	£273.60	£285.00	£342.00

\*Saving based on the value of individual items when bought separately.  
Order any of our selected valves and matching pipe covers at the same time as your radiator.

# Ancona<sup>®</sup> Electric shown on page 29



High quality Italian design & manufacture  
 Steel Multi Column 3 column with wall brackets only  
 Eco Design  
 10 year guarantee on the radiator  
 2 year guarantee on the element

White RAL 9016

**Stock Sizes: 48-72 Hours**

Made to Order Sizes: Up to 5 weeks



The Ancona electric ranges combine the classic Ancona design with the flexibility of a fully controllable electric element. Offering 8 function modes, the Ancona Electric can be set to operate when you wish, on a daily basis, or you can select one of the three pre-set programmes. The Open Window Function detects an open external door or window and will turn the radiator off if it detects that it is allowing heat to escape, saving energy and money.

## Stock options White RAL 9016 New

Height (mm)	Width B (mm)	Sections	Model	Watts $\Delta t$ 50°C	White Ex VAT	White Inc VAT
DELIVERY TIMES				48-72 HOURS		
600	708	14	ANCO3C6063EW	800	£837.00	£1,004.40
	843	17	ANCO3C6076EW	1000	£893.00	£1,071.60
	978	20	ANCO3C6090EW	1200	£949.00	£1,138.80
	1113	23	ANCO3C6010EW	1500	£1,002.00	£1,202.40



Made to order options

Height (mm)	Width B (mm)	Sections	Model	Watts $\Delta t$ 50°C	White Ex VAT	White Inc VAT
DELIVERY TIMES				UP TO 5 WEEKS		
600	439	8	ANCO3C6036EW	400	£732.00	£878.40
	618	12	ANCO3C6054EW	600	£799.00	£958.80
	1383	29	ANCO3C6013EW	2000	£1,106.00	£1,327.20

- IP24
- 8 operating modes: weekly program, 3 integrated pre-set timed programs, pilot-wire facility, comfort, night and antifreeze.
- Open Window Function
- Comfort, Night and Antifreeze
- 2 Year Guarantee on the element

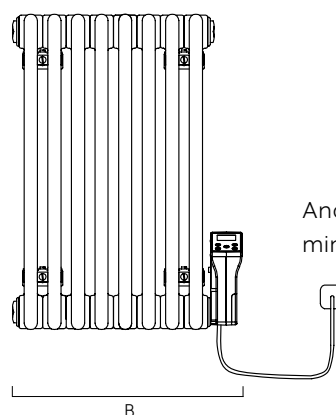
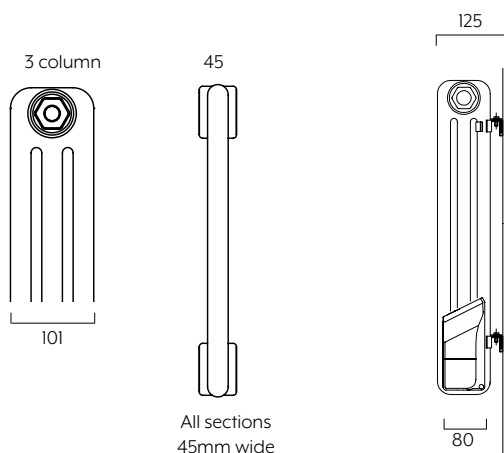

Ancona Electric radiators must be hung a minimum of 150mm off the floor

# Ceramica Collection shown on pages 32-33

High quality Italian design & manufacture.

Recycled Marble radiant panels

Hydronic or Electric versions available

White finish only; choose from 3 different designs - Varenna, Pavia or Senso

All hydronic versions come complete with our 'hidden valve' system including thermostatic valves and flexi hoses

Electric versions; Class II IPX24 with fully programmable digital control

Delivered in up to 6 weeks



Pipe centres	Depth from wall
Pipes come directly out of the wall, 60mm apart.	74mm

Made to order options - Hydronic Vertical

Height (mm)	Width (mm)	Model	Watts Δt 50°C	Btu's Δt 50°C	White Ex VAT	White Inc VAT
DELIVERY TIMES			UP TO 6 WEEKS			
1100	550	CERAV1155	720	2457	£1,809.00	£2,170.80
1500	550	CERAV1555	1200	4094	£2,045.00	£2,454.00
1800	300	CERAV1830	480	1638	£1,792.00	£2,150.40
	550	CERAV1855	1680	5732	£2,187.00	£2,624.40

Please make sure you specify your finish at time of order; Senso, Varenna or Pavia (shown right)

Made to order options - Hydronic Horizontal

Height (mm)	Width (mm)	Model	Watts Δt 50°C	Btu's Δt 50°C	White Ex VAT	White Inc VAT
DELIVERY TIMES			UP TO 6 WEEKS			
550	860	CERAH5586	600	2047	£1,738.00	£2,085.60
	1100	CERAH5511	720	2457	£1,870.00	£2,244.00

Please make sure you specify your finish at time of order; Senso, Varenna or Pavia

- Senso - simple and plain, a lightly textured effect creating an understated statement.
- Varenna- a sense of movement created by the interaction of light and shade across the soft lines and gentle curves of the design.
- Pavia - a natural stone effect finish with a strong bold impact.

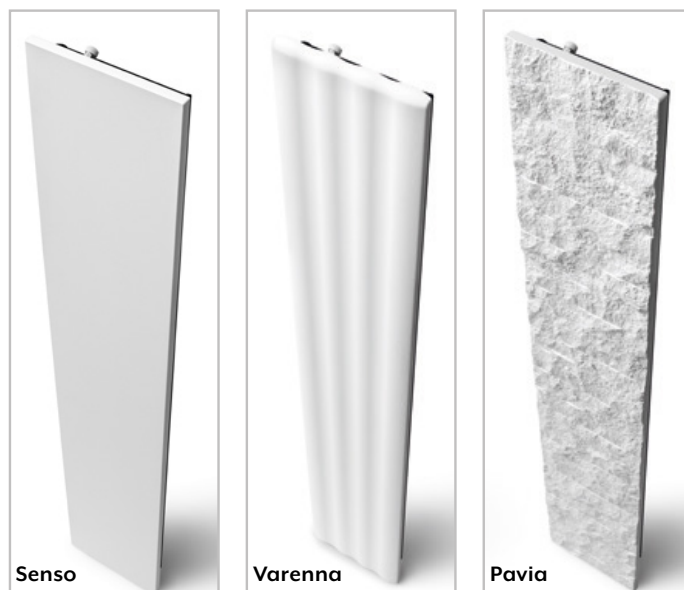

**Please Note: These radiators are very heavy and will require at least two people to lift and fit.**

Made to order options - Electric Vertical

Height (mm)	Width (mm)	Model	Watts Δt 50°C	White Ex VAT	White Inc VAT
DELIVERY TIMES			UP TO 6 WEEKS		
550	860	CERAH5586E	500	£1,616.00	£1,939.20
	1100	CERAH5511E	750	£1,706.00	£2,047.20

Please make sure you specify your finish at time of order; Senso, Varenna or Pavia

Made to order options - Electric Vertical

Height (mm)	Width (mm)	Model	Watts Δt 50°C	White Ex VAT	White Inc VAT
DELIVERY TIMES			UP TO 6 WEEKS		
1000	300	CERAV1030E	250	£1,485.00	£1,782.00
1100	550	CERAV1155E	750	£1,616.00	£1,939.20
1500	550	CERAV1555E	1000	£1,819.00	£2,182.80
1800	300	CERAV1830E	500	£1,600.00	£1,920.00
	550	CERAV1855E	1400	£1,932.00	£2,318.40

Please make sure you specify your finish at time of order; Senso, Varenna or Pavia

**Please Note: These radiators are very heavy and will require at least two people to lift and fit.**

Tested following the European standards and certified by qualified bodies.

Electric safety  
EN 60335-1, 2-30  
EN 62233

Electromagnetic compatibility  
EN 55014-1, -2  
EN 61000-3-2, 3-3



Class II Electric Radiators come with a fully programmable digital display on the side of the radiator that operates a thermostat offering standard settings such as frost protection, comfort mode, eco mode, auto mode, and boost mode.



High quality Italian design & manufacture.  
Ultra slimline extruded Aluminium profile with a curved edge  
CE/UKCA approved & certified to BS EN442.

White RAL 9016 as standard, 23 RAL colours plus 30 Special Finishes.  
Please call **01342 302250** for a RAL or Special Finish chart  
Colour Coordination Service available on stock sizes see page 217 for full details.

### Stock White RAL 9016: 48-72 Hours

Colours & Finishes: Up to 3 weeks (please allow an extra 10 working days for orders of over 10 radiators).

Pipe centres left to right	Pipe centres from wall	Depth from wall
width + valves	65mm	96mm

**SAVE £45\***  
WHEN YOU BUY OUR IDEAL TRV & PIPE COVERS WITH ANY DESIGNER PURCHASE. QUOTE PROMOV1 AT TIME OF ORDER.

Available in White or Chrome.

### Stock options White RAL 9016 - Horizontal

Height (mm)	Width (mm)	Model	Watts Δt 50°C	Btu's Δt 50°C	White Ex VAT	White Inc VAT	Colours Ex VAT	Colours Inc VAT
DELIVERY TIMES					48-72 HOURS		UP TO 3 WEEKS	
500	956	TORR509508H	877	2992	<b>£702.00</b>	<b>£842.40</b>	£877.50	£1,053.00
	1196	TORR501110H	1097	3743	<b>£877.00</b>	<b>£1,052.40</b>	£1,096.25	£1,315.50
	1436	TORR501412H	1316	4490	<b>£1,056.00</b>	<b>£1,267.20</b>	£1,320.00	£1,584.00
600	956	TORR609508H	1007	3436	<b>£740.00</b>	<b>£888.00</b>	£925.00	£1,110.00
	1196	TORR601110H	1259	4296	<b>£928.00</b>	<b>£1,113.60</b>	£1,160.00	£1,392.00
	1436	TORR601412H	1510	5152	<b>£1,115.00</b>	<b>£1,338.00</b>	£1,393.75	£1,672.50

23 RAL colours are shown on page 216

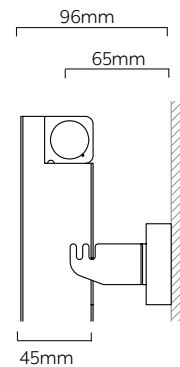
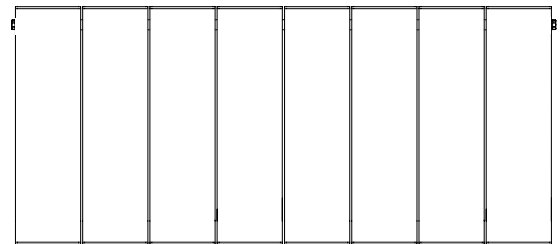

### Stock options White RAL 9016 - Vertical

Height (mm)	Width (mm)	Model	Watts Δt 50°C	Btu's Δt 50°C	White Ex VAT	White Inc VAT	Colours Ex VAT	Colours Inc VAT
DELIVERY TIMES					48-72 HOURS		UP TO 3 WEEKS	
1500	356	TORR153503V	784	2675	<b>£538.00</b>	<b>£645.60</b>	£672.50	£807.00
	476	TORR154704V	1045	3566	<b>£718.00</b>	<b>£861.60</b>	£897.50	£1,077.00
	596	TORR155905V	1306	4456	<b>£897.00</b>	<b>£1,076.40</b>	£1,121.25	£1,345.50
1800	356	TORR183503V	911	3108	<b>£568.00</b>	<b>£681.60</b>	£710.00	£852.00
	476	TORR184704V	1265	4316	<b>£755.00</b>	<b>£906.00</b>	£943.75	£1,132.50
	596	TORR185905V	1527	5210	<b>£942.00</b>	<b>£1,130.40</b>	£1,177.50	£1,413.00

23 RAL colours are shown on page 216

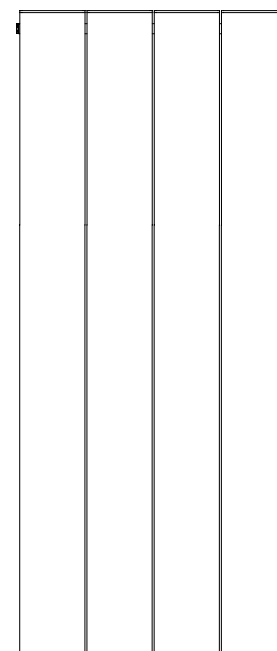

\*Saving based on the value of individual items when bought separately. Order any of our selected valves & matching pipe covers at the same time as your radiator; PROMOV1W (white), PROMOV1C (chrome).

# Niro shown on pages 36-37



High quality Italian design & manufacture.  
Ultra slimline extruded Aluminium profile  
CE/UKCA approved & certified to BS EN442.

White RAL 9016 as standard, 23 RAL colours plus 30 Special Finishes.  
Please call **01342 302250** for a RAL or Special Finish chart  
Colour Coordination Service available on stock sizes see page 217 for full details.

## Stock White RAL 9016: 48-72 Hours

Colours & Finishes: Up to 3 weeks (please allow an extra 10 working days for orders of over 10 radiators).

Pipe centres left to right	Pipe centres from wall	Depth from wall
width + valves	59mm	77mm



**Ideal TRV & Pipe Covers**



**SAVE £45\***  
WHEN YOU BUY OUR IDEAL TRV & PIPE COVERS WITH ANY DESIGNER PURCHASE. QUOTE PROMOV1 AT TIME OF ORDER.

Available in White or Chrome.

## Stock options White RAL 9016 - Horizontal

Height (mm)	Width (mm)	Model	Watts Δt 50°C	Btu's Δt 50°C	White Ex VAT	White Inc VAT	Colours Ex VAT	Colours Inc VAT
DELIVERY TIMES					48-72 HOURS		UP TO 3 WEEKS	
631	799	NIROH637910	710	2423	<b>£770.00</b>	<b>£924.00</b>	£924.00	£1,108.80
	1039	NIROH631013	923	3149	<b>£1,001.00</b>	<b>£1,201.20</b>	£1,201.20	£1,441.44
	1199	NIROH631115	1065	3634	<b>£1,155.00</b>	<b>£1,386.00</b>	£1,386.00	£1,663.20

23 RAL colours are shown on page 216

## Stock options White RAL 9016 - Vertical

Height (mm)	Width (mm)	Model	Watts Δt 50°C	Btu's Δt 50°C	White Ex VAT	White Inc VAT	Colours Ex VAT	Colours Inc VAT
DELIVERY TIMES					48-72 HOURS		UP TO 3 WEEKS	
1831	399	NIROV183905	940	3207	<b>£648.00</b>	<b>£777.60</b>	£777.60	£933.12
	479	NIROV184706	1127	3845	<b>£778.00</b>	<b>£933.60</b>	£933.60	£1,120.32
	559	NIROV185507	1315	4487	<b>£906.00</b>	<b>£1,087.20</b>	£1,087.20	£1,304.64

23 RAL colours are shown on page 216

77mm  
59mm

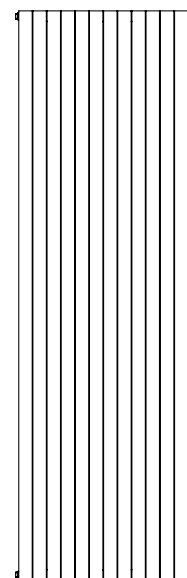
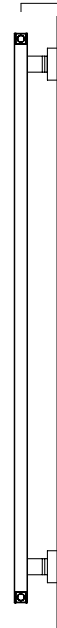

\*Saving based on the value of individual items when bought separately. Order any of our selected valves & matching pipe covers at the same time as your radiator; PROMOV1W (white), PROMOV1C (chrome).

Iseo shown on pages 38-39



High quality Italian design & manufacture.  
85mm extruded Aluminium tubes with a curved edge  
CE/UKCA approved & certified to BS EN442.

White RAL 9016 as standard, 23 RAL colours plus 30 Special Finishes.  
Please call **01342 302250** for a RAL or Special Finish chart  
Colour Coordination Service available on stock sizes see page 217 for full details.

**Stock White RAL 9016: 48-72 Hours**

Colours & Finishes: Up to 3 weeks (please allow an extra 10 working days for orders of over 10 radiators).



**SAVE £45\***  
WHEN YOU BUY OUR IDEAL TRV & PIPE COVERS WITH ANY DESIGNER PURCHASE. QUOTE PROMOV1 AT TIME OF ORDER.



Available in White or Chrome.

Pipe centres left to right	Pipe centres from wall	Depth from wall
width + valves	36mm - 46mm	111mm - 121mm

**Stock options White RAL 9016 - Horizontal**

Height (mm)	Width (mm)	Model	Watts Δt 50°C	Btu's Δt 50°C	White Ex VAT	White Inc VAT	Colours Ex VAT	Colours Inc VAT
DELIVERY TIMES					48-72 HOURS		UP TO 3 WEEKS	
500	845	ISEOH508410	928	3166	£811.00	£973.20	£973.20	£1,167.84
	1015	ISEOH501012	1114	3801	£972.00	£1,166.40	£1,166.40	£1,399.68
	1185	ISEOH501114	1299	4432	£1,134.00	£1,360.80	£1,360.80	£1,632.96
	1440	ISEOH501417	1578	5384	£1,377.00	£1,652.40	£1,652.40	£1,982.88

23 RAL colours are shown on page 216

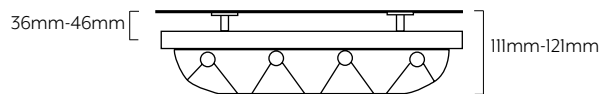

**Stock options White RAL 9016 - Vertical**

Height (mm)	Width (mm)	Model	Watts Δt 50°C	Btu's Δt 50°C	White Ex VAT	White Inc VAT	Colours Ex VAT	Colours Inc VAT
DELIVERY TIMES					48-72 HOURS		UP TO 3 WEEKS	
1800	335	ISEOV183304	977	3334	£583.00	£699.60	£699.60	£839.52
	420	ISEOV184205	1222	4169	£729.00	£874.80	£874.80	£1,049.76
	505	ISEOV185006	1466	5002	£876.00	£1,051.20	£1,051.20	£1,261.44
	590	ISEOV185907	1710	5835	£1,021.00	£1,225.20	£1,225.20	£1,470.24

23 RAL colours are shown on page 216

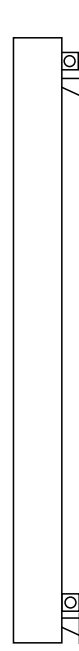

\*Saving based on the value of individual items when bought separately. Order any of our selected valves & matching pipe covers at the same time as your radiator; PROMOV1W (white), PROMOV1C (chrome).





# Odolo shown on pages 42-43

High quality Italian design & manufacture.

Aluminium, 2 column sections

Odolo radiators are protected against corrosion with Aleternum®, an exclusive resin-based internal coating to protect the radiator water chamber. CE/UKCA approved & certified to BS EN442.

White RAL 9010

## White RAL 9010: 48-72 Hours

Pipe centres left to right	Pipe centres from wall	Depth from wall
width + valves	80mm	125mm



**Ideal TRV & Pipe Covers**



**SAVE £45\***  
WHEN YOU BUY OUR IDEAL TRV & PIPE COVERS WITH ANY DESIGNER PURCHASE. QUOTE PROMOV1 AT TIME OF ORDER.

Available in White or Chrome.

## Stock options White RAL 9010 - Horizontal

Height (mm)	Width (mm)	Model	Watts Δt 50°C	Btu's Δt 50°C	White Ex VAT	White Inc VAT
DELIVERY TIMES					48-72 HOURS	
649	474	ODOLH644709	574	1958	£737.00	£884.40
	624	ODOLH646212	766	2614	£964.00	£1,156.80
	824	ODOLH648216	1021	3484	£1,266.00	£1,519.20
	1024	ODOLH641020	1276	4354	£1,569.00	£1,882.80
	1224	ODOLH641224	1531	5224	£1,871.00	£2,245.20

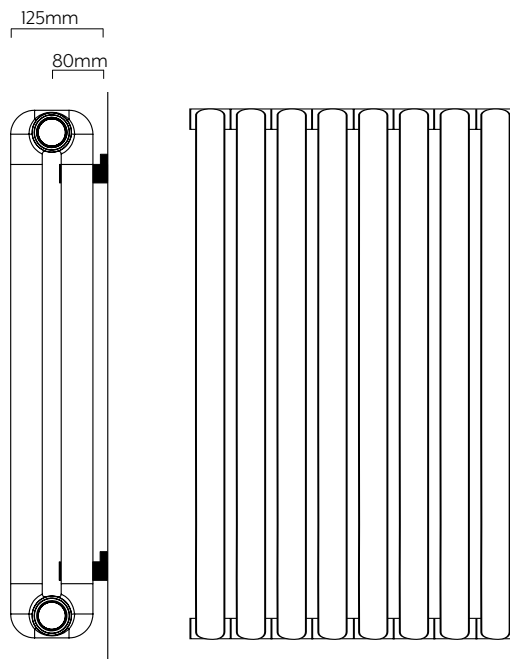

## Stock options White RAL 9010 - Vertical

Height (mm)	Width (mm)	Model	Watts Δt 50°C	Btu's Δt 50°C	White Ex VAT	White Inc VAT
DELIVERY TIMES					48-72 HOURS	
1849	324	ODOLV183206	1016	3467	£651.00	£781.20
	424	ODOLV184208	1355	4623	£850.00	£1,020.00
	474	ODOLV184709	1525	5203	£949.00	£1,138.80
	524	ODOLV185210	1694	5780	£1,049.00	£1,258.80
	624	ODOLV186212	2033	6937	£1,247.00	£1,496.40

®Aleternum

\*Saving based on the value of individual items when bought separately. Order any of our selected valves & matching pipe covers at the same time as your radiator; PROMOV1W (white), PROMOV1C (chrome).

# Canto shown on page 44



High quality Italian design & manufacture.  
95mm sections Aluminium radiator  
CE/UKCA approved & certified to BS EN442.

White RAL 9010 as standard, 23 RAL colours plus 30 Special Finishes  
Please call **01342 302250** for a RAL or Special Finish chart  
Colour Coordination Service available on stock sizes see page 217 for full details.

## Stock White RAL 9010: 48-72 Hours

Colours & Finishes: Up to 3 weeks (please allow an extra 10 working days for orders of over 10 radiators).



**Ideal TRV & Pipe Covers**



**SAVE £45\***  
WHEN YOU BUY OUR IDEAL TRV & PIPE COVERS WITH ANY DESIGNER PURCHASE. QUOTE PROMOV1 AT TIME OF ORDER.

Available in White or Chrome.

Pipe centres left to right	Pipe centres from wall	Depth from wall
width + valves	70mm	120mm

## Stock options White RAL 9010 - Horizontal

Height (mm)	Width (mm)	Model	Watts Δt 50°C	Btu's Δt 50°C	White Ex VAT	White Inc VAT	Colours Ex VAT	Colours Inc VAT
DELIVERY TIMES					48-72 HOURS		UP TO 3 WEEKS	
568	420	CANT564208H	488	1665	<b>£250.00</b>	<b>£300.00</b>	£312.50	£375.00
	620	CANT566212H	732	2498	<b>£364.00</b>	<b>£436.80</b>	£455.00	£546.00
	820	CANT568216H	976	3330	<b>£482.00</b>	<b>£578.40</b>	£602.50	£723.00
	1020	CANT561020H	1220	4163	<b>£595.00</b>	<b>£714.00</b>	£743.75	£892.50
668	420	CANT664208H	552	1883	<b>£255.00</b>	<b>£306.00</b>	£318.75	£382.50
	620	CANT666212H	828	2825	<b>£373.00</b>	<b>£447.60</b>	£466.25	£559.50
	820	CANT668216H	1104	3767	<b>£492.00</b>	<b>£590.40</b>	£615.00	£738.00
	1020	CANT661020H	1380	4709	<b>£611.00</b>	<b>£733.20</b>	£763.75	£916.50

23 RAL colours are shown on page 197

Please note widths include measurements for bushes

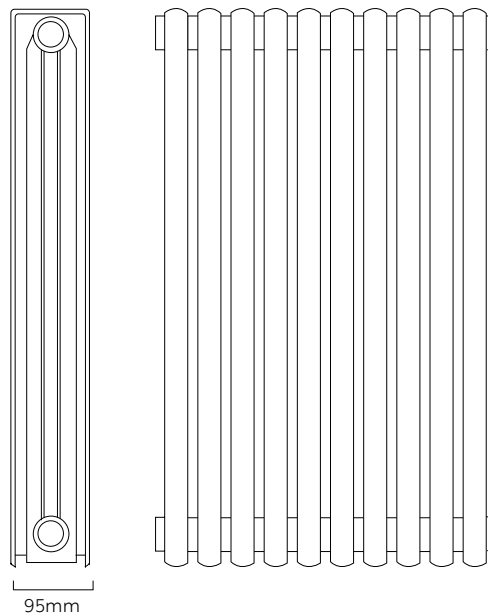
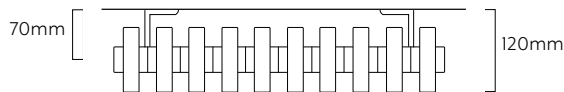

## Stock options White RAL 9010 - Vertical

Height (mm)	Width (mm)	Model	Watts Δt 50°C	Btu's Δt 50°C	White Ex VAT	White Inc VAT	Colours Ex VAT	Colours Inc VAT
DELIVERY TIMES					48-72 HOURS		UP TO 3 WEEKS	
1470	270	CANT142705V	715	2440	<b>£445.00</b>	<b>£534.00</b>	£556.25	£667.50
	420	CANT144208V	1144	3903	<b>£699.00</b>	<b>£838.80</b>	£873.75	£1,048.50
	520	CANT145210V	1430	4879	<b>£866.00</b>	<b>£1,039.20</b>	£1,082.50	£1,299.00
1870	270	CANT182705V	890	3037	<b>£525.00</b>	<b>£630.00</b>	£656.25	£787.50
	420	CANT184208V	1424	4859	<b>£827.00</b>	<b>£992.40</b>	£1,033.75	£1,240.50
	520	CANT185210V	1780	6073	<b>£1,028.00</b>	<b>£1,233.60</b>	£1,285.00	£1,542.00

23 RAL colours are shown on page 197

Please note widths include measurements for bushes

\*Saving based on the value of individual items when bought separately. Order any of our selected valves & matching pipe covers at the same time as your radiator; PROMOV1W (white), PROMOV1C (chrome).

# Ellipsis Stainless Steel shown on page 45

Stainless Steel; 25mm x 50mm oval tubes  
CE/UKCA approved & certified to BS EN442.

Polished or Brushed Stainless Steel

**All sizes delivered in 48-72 Hours**



**SAVE £45\***  
WHEN YOU BUY OUR IDEAL TRV & PIPE COVERS WITH ANY DESIGNER PURCHASE. QUOTE PROMOV1 AT TIME OF ORDER.



Available in White or Chrome.

Pipe centres left to right	Pipe centres from wall	Depth from wall
width + valves	50mm	90mm

## Single Vertical - Polished Stainless Steel

Height (mm)	Width (mm)	Model	Watts Δt 50°C	Btu's Δt 50°C	Polished Stainless Steel Ex VAT	Polished Stainless Steel Inc VAT
DELIVERY TIMES					<b>48-72 HOURS</b>	
1800	295	ELLISV182905PO	389	1327	<b>£469.00</b>	<b>£562.80</b>
	413	ELLISV184107PO	544	1856	<b>£625.00</b>	<b>£750.00</b>

## Double Vertical - Polished Stainless Steel

Height (mm)	Width (mm)	Model	Watts Δt 50°C	Btu's Δt 50°C	Polished Stainless Steel Ex VAT	Polished Stainless Steel Inc VAT
DELIVERY TIMES					<b>48-72 HOURS</b>	
1800	295	ELLIDV182910PO	624	2129	<b>£825.00</b>	<b>£990.00</b>
	413	ELLIDV184114PO	927	3163	<b>£1,078.00</b>	<b>£1,293.60</b>

## Single Vertical - Brushed Stainless Steel

Height (mm)	Width (mm)	Model	Watts Δt 50°C	Btu's Δt 50°C	Brushed Stainless Steel Ex VAT	Brushed Stainless Steel Inc VAT
DELIVERY TIMES					<b>48-72 HOURS</b>	
1800	295	ELLISV182905BR	389	1327	<b>£469.00</b>	<b>£562.80</b>
	413	ELLISV184107BR	544	1856	<b>£625.00</b>	<b>£750.00</b>

## Double Vertical - Brushed Stainless Steel

Height (mm)	Width (mm)	Model	Watts Δt 50°C	Btu's Δt 50°C	Brushed Stainless Steel Ex VAT	Brushed Stainless Steel Inc VAT
DELIVERY TIMES					<b>48-72 HOURS</b>	
1800	295	ELLIDV182910BR	624	2129	<b>£825.00</b>	<b>£990.00</b>
	413	ELLIDV184114BR	927	3163	<b>£1,078.00</b>	<b>£1,293.60</b>

Single

Double

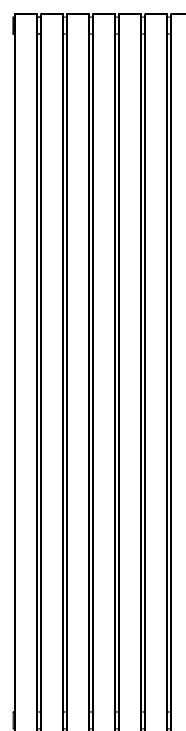
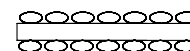

\*Saving based on the value of individual items when bought separately. Order any of our selected valves & matching pipe covers at the same time as your radiator; PROMOV1W (white), PROMOV1C (chrome).









# Sitar Single Horizontal shown on pages 48-49



High quality Italian design & manufacture.  
Steel; 23mm round tubes  
CE/UKCA approved & certified to BS EN442.



White RAL 9016 as standard, 188 RAL colours plus 30 Special Finishes  
Please call **01342 302250** for a RAL or Special Finish chart  
Colour Coordination Service available on stock sizes see page 217 for full details.

## Stock White RAL 9016: 48-72 Hours

Made to Order sizes & colours: Up to 5 weeks.



**Ideal TRV & Pipe Covers**



**SAVE £45\***  
WHEN YOU BUY OUR IDEAL TRV & PIPE COVERS WITH ANY DESIGNER PURCHASE. QUOTE PROMOV1 AT TIME OF ORDER.

Available in White or Chrome.

Pipe centres left to right	Pipe centres from wall	Depth from wall
width - 50mm	55mm	90mm

## Stock options White RAL 9016 - Single Horizontal

Height (mm)	Width (mm)	Model	Watts Δt 50°C	Btu's Δt 50°C	White Ex VAT	White Inc VAT	Colours Ex VAT	Colours Inc VAT
DELIVERY TIMES					48-72 HOURS		UP TO 5 WEEKS	
402	920	SITASH409212	515	1757	<b>£375.00</b>	<b>£450.00</b>	£468.75	£562.50
	1220	SITASH401212	683	2330	<b>£395.00</b>	<b>£474.00</b>	£493.75	£592.50
	1520	SITASH401512	851	2904	<b>£411.00</b>	<b>£493.20</b>	£513.75	£616.50
504	520	SITASH505215	361	1232	<b>£382.00</b>	<b>£458.40</b>	£477.50	£573.00
	650	SITASH506515	451	1539	<b>£392.00</b>	<b>£470.40</b>	£490.00	£588.00
	700	SITASH507015	486	1658	<b>£400.00</b>	<b>£480.00</b>	£500.00	£600.00
	920	SITASH509215	639	2180	<b>£414.00</b>	<b>£496.80</b>	£517.50	£621.00
	1220	SITASH501215	848	2893	<b>£437.00</b>	<b>£524.40</b>	£546.25	£655.50
538	1520	SITASH501515	1056	3603	<b>£455.00</b>	<b>£546.00</b>	£568.75	£682.50
	920	SITASH539216	681	2324	<b>£426.00</b>	<b>£511.20</b>	£532.50	£639.00
	1220	SITASH531216	903	3081	<b>£450.00</b>	<b>£540.00</b>	£562.50	£675.00
606	1520	SITASH531516	1124	3835	<b>£472.00</b>	<b>£566.40</b>	£590.00	£708.00
	650	SITASH606518	537	1832	<b>£426.00</b>	<b>£511.20</b>	£532.50	£639.00
	700	SITASH607018	578	1972	<b>£440.00</b>	<b>£528.00</b>	£550.00	£660.00
606	920	SITASH609218	760	2593	<b>£459.00</b>	<b>£550.80</b>	£573.75	£688.50
	1220	SITASH601218	1009	3443	<b>£481.00</b>	<b>£577.20</b>	£601.25	£721.50
	1520	SITASH601518	1257	4289	<b>£504.00</b>	<b>£604.80</b>	£630.00	£756.00

Single

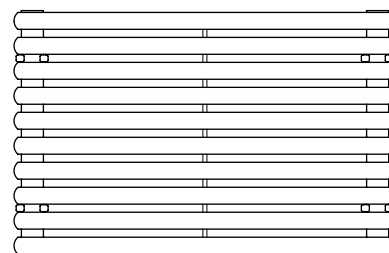
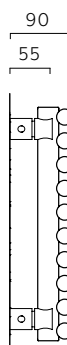

## Made to order options - Single Horizontal

Height (mm)	Width (mm)	Model	Watts Δt 50°C	Btu's Δt 50°C	White Ex VAT	White Inc VAT	Colours Ex VAT	Colours Inc VAT
DELIVERY TIMES					UP TO 5 WEEKS		UP TO 5 WEEKS	
300	520	SITASH305209	218	744	£316.00	£379.20	£395.00	£474.00
	650	SITASH306509	272	928	£322.00	£386.40	£402.50	£483.00
	700	SITASH307009	293	1000	£329.00	£394.80	£411.25	£493.50
	920	SITASH309209	386	1317	£338.00	£405.60	£422.50	£507.00
	1220	SITASH301209	512	1747	£352.00	£422.40	£440.00	£528.00
	1520	SITASH301509	638	2177	£365.00	£438.00	£456.25	£547.50
	1820	SITASH301809	764	2607	£377.00	£452.40	£471.25	£565.50
	2020	SITASH302009	848	2893	£384.00	£460.80	£480.00	£576.00
402	520	SITASH405212	291	993	£347.00	£416.40	£433.75	£520.50
	650	SITASH406512	363	1239	£355.00	£426.00	£443.75	£532.50
	700	SITASH407012	391	1334	£361.00	£433.20	£451.25	£541.50
	1820	SITASH401812	1018	3473	£426.00	£511.20	£532.50	£639.00
504	2020	SITASH402012	1130	3856	£437.00	£524.40	£546.25	£655.50
	1820	SITASH501815	1265	4316	£476.00	£571.20	£595.00	£714.00
2020	SITASH502015	1404	4790	£490.00	£588.00	£612.50	£735.00	

Height (mm)	Width (mm)	Model	Watts Δt 50°C	Btu's Δt 50°C	White Ex VAT	White Inc VAT	Colours Ex VAT	Colours Inc VAT
DELIVERY TIMES					UP TO 5 WEEKS		UP TO 5 WEEKS	
606	1820	SITASH601818	1505	5135	£525.00	£630.00	£656.25	£787.50
	2020	SITASH602018	1670	5698	£540.00	£648.00	£675.00	£810.00
708	650	SITASH706521	620	2115	£458.00	£549.60	£572.50	£687.00
	700	SITASH707021	667	2276	£470.00	£564.00	£587.50	£705.00
	920	SITASH709221	877	2992	£492.00	£590.40	£615.00	£738.00
	1220	SITASH701221	1164	3972	£521.00	£625.20	£651.25	£781.50
	1520	SITASH701521	1450	4947	£549.00	£658.80	£686.25	£823.50
	1820	SITASH701821	1736	5923	£574.00	£688.80	£717.50	£861.00
	2020	SITASH702021	1927	6575	£590.00	£708.00	£737.50	£885.00
810	650	SITASH816524	700	2388	£492.00	£590.40	£615.00	£738.00
	700	SITASH817024	754	2573	£505.00	£606.00	£631.25	£757.50
	920	SITASH819224	991	3381	£527.00	£632.40	£658.75	£790.50
	1220	SITASH811224	1314	4483	£561.00	£673.20	£701.25	£841.50
	1520	SITASH811524	1637	5585	£592.00	£710.40	£740.00	£888.00
	1820	SITASH811824	1961	6691	£622.00	£746.40	£777.50	£933.00
	2020	SITASH812024	2176	7425	£644.00	£772.80	£805.00	£966.00

\*Saving based on the value of individual items when bought separately. Order any of our selected valves & matching pipe covers at the same time as your radiator; PROMOV1W (white), PROMOV1C (chrome).



# Sitar Double Horizontal shown on pages 48-49



High quality Italian design & manufacture.  
Steel; 23mm round tubes  
CE/UKCA approved & certified to BS EN442.



White RAL 9016 as standard, 188 RAL colours plus 30 Special Finishes  
Please call **01342 302250** for a RAL or Special Finish chart  
Colour Coordination Service available on stock sizes see page 217 for full details.



## Stock White RAL 9016: 48-72 Hours

Made to Order sizes & colours: Up to 5 weeks.

Pipe centres left to right	Pipe centres from wall	Depth from wall
width - 50mm	79mm to 89mm	114mm to 124mm

**SAVE £45\***  
WHEN YOU BUY OUR IDEAL TRV & PIPE COVERS WITH ANY DESIGNER PURCHASE. QUOTE PROMOV1 AT TIME OF ORDER.

Available in White or Chrome.

## Stock options White RAL 9016 - Double Horizontal

Height (mm)	Width (mm)	Model	Watts Δt 50°C	Btu's Δt 50°C	White Ex VAT	White Inc VAT	Colours Ex VAT	Colours Inc VAT
DELIVERY TIMES					48-72 HOURS		UP TO 5 WEEKS	
402	920	SITADH409212	782	2668	£587.00	£704.40	£733.75	£880.50
	1220	SITADH401212	1037	3538	£622.00	£746.40	£777.50	£933.00
	1520	SITADH401512	1292	4408	£657.00	£788.40	£821.25	£985.50
	1820	SITADH401812	1547	5278	£683.00	£819.60	£853.75	£1,024.50
504	520	SITADH505215	527	1798	£608.00	£729.60	£760.00	£912.00
	650	SITADH506515	658	2245	£617.00	£740.40	£771.25	£925.50
	700	SITADH507015	709	2419	£629.00	£754.80	£786.25	£943.50
	920	SITADH509215	937	3197	£645.00	£774.00	£806.25	£967.50
	1220	SITADH501215	1235	4214	£689.00	£826.80	£861.25	£1,033.50
	1520	SITADH501515	1540	5254	£730.00	£876.00	£912.50	£1,095.00
538	1820	SITADH501815	1844	6292	£759.00	£910.80	£948.75	£1,138.50
	920	SITADH539216	955	3258	£664.00	£796.80	£830.00	£996.00
	1220	SITADH531216	1266	4320	£710.00	£852.00	£887.50	£1,065.00
	1520	SITADH531516	1577	5381	£754.00	£904.80	£942.50	£1,131.00
606	650	SITADH606518	732	2498	£668.00	£801.60	£835.00	£1,002.00
	700	SITADH607018	789	2692	£682.00	£818.40	£852.50	£1,023.00
	920	SITADH609218	1037	3538	£705.00	£846.00	£881.25	£1,057.50
	1220	SITADH601218	1375	4692	£754.00	£904.80	£942.50	£1,131.00
	1520	SITADH601518	1713	5845	£804.00	£964.80	£1,005.00	£1,206.00
	1820	SITADH601818	2051	6998	£838.00	£1,005.60	£1,047.50	£1,257.00

Double

114-124

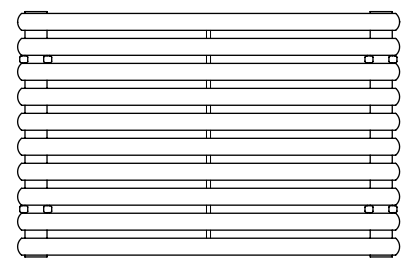
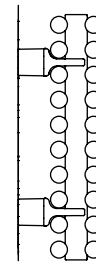

## Made to order options - Double Horizontal

Height (mm)	Width (mm)	Model	Watts Δt 50°C	Btu's Δt 50°C	White Ex VAT	White Inc VAT	Colours Ex VAT	Colours Inc VAT
DELIVERY TIMES					UP TO 5 WEEKS		UP TO 5 WEEKS	
300	520	SITADH305209	378	1290	£505.00	£606.00	£631.25	£757.50
	650	SITADH306509	473	1614	£509.00	£610.80	£636.25	£763.50
	700	SITADH307009	509	1737	£517.00	£620.40	£646.25	£775.50
	920	SITADH309209	669	2283	£535.00	£642.00	£668.75	£802.50
	1220	SITADH301209	887	3026	£560.00	£672.00	£700.00	£840.00
	1520	SITADH301509	1105	3770	£584.00	£700.80	£730.00	£876.00
	1820	SITADH301809	1323	4514	£603.00	£723.60	£753.75	£904.50
	2020	SITADH302009	1468	5009	£613.00	£735.60	£766.25	£919.50
402	520	SITADH405212	442	1508	£557.00	£668.40	£696.25	£835.50
	650	SITADH406512	552	1883	£562.00	£674.40	£702.50	£843.00
	700	SITADH407012	595	2030	£570.00	£684.00	£712.50	£855.00
	2020	SITADH402012	1717	5858	£696.00	£835.20	£870.00	£1,044.00
504	2020	SITADH502015	2046	6981	£780.00	£936.00	£975.00	£1,170.00
606	2020	SITADH602018	2276	7766	£864.00	£1,036.80	£1,080.00	£1,296.00

Height (mm)	Width (mm)	Model	Watts Δt 50°C	Btu's Δt 50°C	White Ex VAT	White Inc VAT	Colours Ex VAT	Colours Inc VAT
DELIVERY TIMES					UP TO 5 WEEKS		UP TO 5 WEEKS	
708	650	SITADH706521	829	2829	£723.00	£867.60	£903.75	£1,084.50
	700	SITADH707021	893	3047	£738.00	£885.60	£922.50	£1,107.00
	920	SITADH709221	1174	4006	£763.00	£915.60	£953.75	£1,144.50
	1220	SITADH701221	1556	5309	£821.00	£985.20	£1,026.25	£1,231.50
	1520	SITADH701521	1939	6616	£877.00	£1,052.40	£1,096.25	£1,315.50
	1820	SITADH701821	2322	7923	£916.00	£1,099.20	£1,145.00	£1,374.00
	2020	SITADH702021	2577	8793	£946.00	£1,135.20	£1,182.50	£1,419.00
	810	650	SITADH816524	901	3074	£777.00	£932.40	£971.25
700		SITADH817024	970	3310	£795.00	£954.00	£993.75	£1,192.50
920		SITADH819224	1275	4350	£824.00	£988.80	£1,030.00	£1,236.00
1220		SITADH811224	1691	5770	£888.00	£1,065.60	£1,110.00	£1,332.00
1520		SITADH811524	2107	7189	£948.00	£1,137.60	£1,185.00	£1,422.00
1820		SITADH811824	2523	8608	£996.00	£1,195.20	£1,245.00	£1,494.00
2020		SITADH812024	2800	9554	£1,026.00	£1,231.20	£1,282.50	£1,539.00

\*Saving based on the value of individual items when bought separately. Order any of our selected valves & matching pipe covers at the same time as your radiator; PROMOV1W (white), PROMOV1C (chrome).





# Sax® Horizontal shown on pages 50-51



High quality Italian design & manufacture.  
Steel; 20mm x 25mm tubes with 30mm collectors  
CE/UKCA approved & certified to BS EN442.



White RAL 9016 as standard, 188 RAL colours plus 30 Special Finishes  
Please call **01342 302250** for a RAL or Special Finish chart  
Colour Coordination Service available on stock sizes see page 217 for full details.



## Stock White RAL 9016: 48-72 Hours

Made to Order sizes & colours: Up to 5 weeks

**SAVE £45\***  
WHEN YOU BUY OUR IDEAL TRV & PIPE COVERS WITH ANY DESIGNER PURCHASE. QUOTE PROMOV1 AT TIME OF ORDER.

Available in White or Chrome.

## Stock options White RAL 9016 - Single Horizontal

Height (mm)	Width (mm)	Model	Watts Δt50°C	Btu's Δt50°C	White Ex VAT	White Inc VAT	Colours Ex VAT	Colours Inc VAT
DELIVERY TIMES					48-72 HOURS		UP TO 5 WEEKS	
520	1200	SAXSH521213	799	2726	£589.00	£706.80	£736.25	£883.50
600	900	SAXSH609015	686	2341	£591.00	£709.20	£738.75	£886.50
	1200	SAXSH601215	915	3122	£627.00	£752.40	£783.75	£940.50

Pipe centres left to right	Pipe centres from wall	Depth from wall
width - 30mm	55mm	95mm

Made to order options - Single Horizontal

Height (mm)	Width (mm)	Model	Watts Δt 50°C	Btu's Δt 50°C	White Ex VAT	White Inc VAT	Colours Ex VAT	Colours Inc VAT
DELIVERY TIMES					UP TO 5 WEEKS		UP TO 5 WEEKS	
400	900	SAXSH409010	465	1587	£487.00	£584.40	£608.75	£730.50
	1200	SAXSH401210	621	2119	£509.00	£610.80	£636.25	£763.50
	1500	SAXSH401510	776	2648	£535.00	£642.00	£668.75	£802.50
	1800	SAXSH401810	931	3177	£554.00	£664.80	£692.50	£831.00
520	900	SAXSH529013	599	2044	£554.00	£664.80	£692.50	£831.00
	1500	SAXSH521513	999	3409	£620.00	£744.00	£775.00	£930.00
	1800	SAXSH521813	1199	4091	£644.00	£772.80	£805.00	£966.00
600	1500	SAXSH601515	1144	3903	£663.00	£795.60	£828.75	£994.50
	1800	SAXSH601815	1373	4685	£694.00	£832.80	£867.50	£1,041.00

## Single

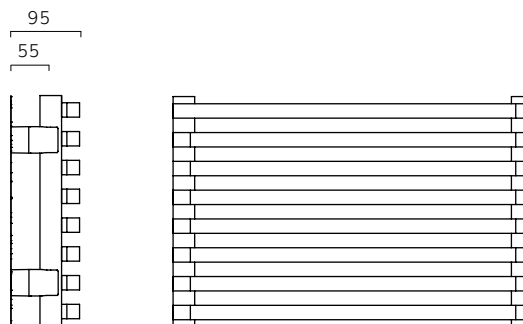

## Stock options White RAL 9016 - Double Horizontal

Height (mm)	Width (mm)	Model	Watts Δt 50°C	Btu's Δt 50°C	White Ex VAT	White Inc VAT	Colours Ex VAT	Colours Inc VAT
DELIVERY TIMES					48-72 HOURS		UP TO 5 WEEKS	
520	1200	SAXDH521213	1272	4340	£1,093.00	£1,311.60	£1,366.25	£1,639.50
600	900	SAXDH609015	1066	3637	£1,111.00	£1,333.20	£1,388.75	£1,666.50
	1200	SAXDH601215	1422	4852	£1,168.00	£1,401.60	£1,460.00	£1,752.00

Pipe centres left to right	Pipe centres from wall	Depth from wall
width - 30mm	76mm to 82mm	116mm to 122mm

Made to order options - Double Horizontal

Height (mm)	Width (mm)	Model	Watts Δt 50°C	Btu's Δt 50°C	White Ex VAT	White Inc VAT	Colours Ex VAT	Colours Inc VAT
DELIVERY TIMES					UP TO 5 WEEKS		UP TO 5 WEEKS	
400	900	SAXDH409010	777	2651	£910.00	£1,092.00	£1,137.50	£1,365.00
	1200	SAXDH401210	1036	3535	£948.00	£1,137.60	£1,185.00	£1,422.00
	1500	SAXDH401510	1295	4419	£987.00	£1,184.40	£1,233.75	£1,480.50
	1800	SAXDH401810	1554	5302	£1,057.00	£1,268.40	£1,321.25	£1,585.50
520	900	SAXDH529013	954	3255	£1,042.00	£1,250.40	£1,302.50	£1,563.00
	1500	SAXDH521513	1591	5428	£1,144.00	£1,372.80	£1,430.00	£1,716.00
	1800	SAXDH521813	1909	6514	£1,224.00	£1,468.80	£1,530.00	£1,836.00
600	1500	SAXDH601515	1777	6063	£1,224.00	£1,468.80	£1,530.00	£1,836.00
	1800	SAXDH601815	2133	7278	£1,309.00	£1,570.80	£1,636.25	£1,963.50

## Double

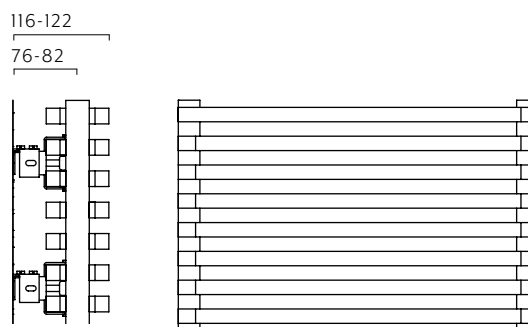

® Sax is an IRSAP Group registered design

\*Saving based on the value of individual items when bought separately.

Order any of our selected valves & matching pipe covers at the same time as your radiator; PROMOV1W (white), PROMOV1C (chrome).



High quality Italian design & manufacture.  
Steel; 20mm x 25mm tubes with 30mm collectors  
CE/UKCA approved & certified to BS EN442.



White RAL 9016 as standard, 188 RAL colours plus 30 Special Finishes  
Please call **01342 302250** for a RAL or Special Finish chart  
Colour Coordination Service available on stock sizes see page 217 for full details.



## Stock White RAL 9016: 48-72 Hours

Made to Order sizes & colours: Up to 5 weeks.

**SAVE £45\***  
WHEN YOU BUY OUR IDEAL TRV & PIPE COVERS WITH ANY DESIGNER PURCHASE. QUOTE PROMOV1 AT TIME OF ORDER.



**Ideal TRV & Pipe Covers**

Available in White or Chrome.

## Stock options White RAL 9016 - Single Vertical

Height (mm)	Width (mm)	Model	Watts Δt 50°C	Btu's Δt 50°C	White Ex VAT	White Inc VAT	Colours Ex VAT	Colours Inc VAT
DELIVERY TIMES					48-72 HOURS		UP TO 5 WEEKS	
1800	400	SAXSV184010	861	2938	£554.00	£664.80	£692.50	£831.00
	520	SAXSV185213	1119	3818	£644.00	£772.80	£805.00	£966.00

Made to order options - Single Vertical

Height (mm)	Width (mm)	Model	Watts Δt 50°C	Btu's Δt 50°C	White Ex VAT	White Inc VAT	Colours Ex VAT	Colours Inc VAT
DELIVERY TIMES					UP TO 5 WEEKS		UP TO 5 WEEKS	
1200	280	SAXSV122807	411	1402	£470.00	£564.00	£587.50	£705.00
	400	SAXSV124010	588	2006	£509.00	£610.80	£636.25	£763.50
	520	SAXSV125213	764	2607	£589.00	£706.80	£736.25	£883.50
	600	SAXSV126015	882	3009	£627.00	£752.40	£783.75	£940.50
1500	280	SAXSV152807	506	1726	£491.00	£589.20	£613.75	£736.50
	400	SAXSV154010	723	2467	£535.00	£642.00	£668.75	£802.50
	520	SAXSV155213	940	3207	£620.00	£744.00	£775.00	£930.00
	600	SAXSV156015	1085	3702	£663.00	£795.60	£828.75	£994.50
1800	280	SAXSV182807	603	2057	£506.00	£607.20	£632.50	£759.00
	600	SAXSV186015	1292	4408	£694.00	£832.80	£867.50	£1,041.00
2000	280	SAXSV202807	669	2283	£517.00	£620.40	£646.25	£775.50
	400	SAXSV204010	955	3258	£564.00	£676.80	£705.00	£846.00
	520	SAXSV205213	1242	4238	£663.00	£795.60	£828.75	£994.50
	600	SAXSV206015	1433	4889	£712.00	£854.40	£890.00	£1,068.00

### Single



Pipe centres left to right	Pipe centres from wall	Depth from wall
width + valves	55mm	95mm

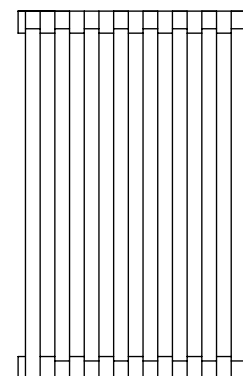
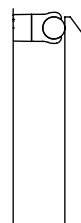

## Stock options White RAL 9016 - Double Vertical

Height (mm)	Width (mm)	Model	Watts Δt 50°C	Btu's Δt 50°C	White Ex VAT	White Inc VAT	Colours Ex VAT	Colours Inc VAT
DELIVERY TIMES					48-72 HOURS		UP TO 5 WEEKS	
1800	400	SAXDV184010	1356	4627	£1,057.00	£1,268.40	£1,321.25	£1,585.50
	520	SAXDV185213	1762	6012	£1,224.00	£1,468.80	£1,530.00	£1,836.00

### Double



Pipe centres left to right	Pipe centres from wall	Depth from wall
width + valves	76mm to 82mm	116mm to 122mm

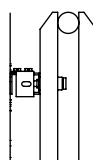

Made to order options - Double Vertical

Height (mm)	Width (mm)	Model	Watts Δt 50°C	Btu's Δt 50°C	White Ex VAT	White Inc VAT	Colours Ex VAT	Colours Inc VAT
DELIVERY TIMES					UP TO 5 WEEKS		UP TO 5 WEEKS	
1200	280	SAXDV122807	668	2279	£877.00	£1,052.40	£1,096.25	£1,315.50
	400	SAXDV124010	954	3255	£948.00	£1,137.60	£1,185.00	£1,422.00
	520	SAXDV125213	1240	4231	£1,093.00	£1,311.60	£1,366.25	£1,639.50
	600	SAXDV126015	1431	4883	£1,168.00	£1,401.60	£1,460.00	£1,752.00
1500	280	SAXDV152807	811	2767	£905.00	£1,086.00	£1,131.25	£1,357.50
	400	SAXDV154010	1159	3955	£987.00	£1,184.40	£1,233.75	£1,480.50
	520	SAXDV155213	1507	5142	£1,144.00	£1,372.80	£1,430.00	£1,716.00
	600	SAXDV156015	1738	5930	£1,224.00	£1,468.80	£1,530.00	£1,836.00

Height (mm)	Width (mm)	Model	Watts Δt 50°C	Btu's Δt 50°C	White Ex VAT	White Inc VAT	Colours Ex VAT	Colours Inc VAT
DELIVERY TIMES					UP TO 5 WEEKS		UP TO 5 WEEKS	
1800	280	SAXDV182807	949	3238	£970.00	£1,164.00	£1,212.50	£1,455.00
	600	SAXDV186015	2033	6937	£1,309.00	£1,570.80	£1,636.25	£1,963.50
2000	280	SAXDV202807	1038	3542	£1,036.00	£1,243.20	£1,295.00	£1,554.00
	400	SAXDV204010	1483	5060	£1,126.00	£1,351.20	£1,407.50	£1,689.00
	520	SAXDV205213	1927	6575	£1,306.00	£1,567.20	£1,632.50	£1,959.00
600	SAXDV206015	2224	7588	£1,399.00	£1,678.80	£1,748.75	£2,098.50	

\*Saving based on the value of individual items when bought separately.  
Order any of our selected valves & matching pipe covers at the same time as your radiator; PROMOV1W (white), PROMOV1C (chrome).





# Water Lily shown on page 54

High quality Italian design & manufacture.  
Steel; 70mm flat tubes with 30mm collectors  
Underneath (B2) connections as standard  
CE/UKCA approved & certified to BS EN442.

White RAL 9016 as standard, 188 RAL colours plus 30 Special Finishes  
Please call **01342 302250** for a RAL or Special Finish chart.

## Stock White RAL 9016: 48-72 Hours

Made to Order sizes & colours: Up to 5 weeks.



**Ideal TRV & Pipe Covers**



**SAVE £45\***  
WHEN YOU BUY OUR IDEAL TRV & PIPE COVERS WITH ANY DESIGNER PURCHASE. QUOTE PROMOV1 AT TIME OF ORDER.

Available in White or Chrome.

Water Lily	Pipe centres left to right	Pipe centres from wall	Depth from wall
Water Lily Single	width - 84mm	55mm - 65mm	79mm - 89mm
Water Lily Double	width - 84mm	67mm - 77mm	91mm - 101mm

Please note: underneath connections only

## Stock options White RAL 9016 - Single Vertical

Height (mm)	Width (mm)	Model	Watts Δt 50°C	Btu's Δt 50°C	White Ex VAT	White Inc VAT	Colours Ex VAT	Colours Inc VAT
DELIVERY TIMES					48-72 HOURS		UP TO 5 WEEKS	
1820	160	WATESI81602	294	1003	<b>£285.00</b>	<b>£342.00</b>	£356.25	£427.50
	236	WATESI82303	441	1505	<b>£333.00</b>	<b>£399.60</b>	£416.25	£499.50
	312	WATESI83104	588	2006	<b>£370.00</b>	<b>£444.00</b>	£462.50	£555.00
	388	WATESI83805	735	2508	<b>£428.00</b>	<b>£513.60</b>	£535.00	£642.00
	464	WATESI84606	881	3006	<b>£488.00</b>	<b>£585.60</b>	£610.00	£732.00
2020	160	WATES201602	328	1119	<b>£492.00</b>	<b>£590.40</b>	£615.00	£738.00
	236	WATES202303	492	1679	<b>£547.00</b>	<b>£656.40</b>	£683.75	£820.50
	312	WATES203104	656	2238	<b>£600.00</b>	<b>£720.00</b>	£750.00	£900.00
	388	WATES203805	820	2798	<b>£664.00</b>	<b>£796.80</b>	£830.00	£996.00
	464	WATES204606	984	3357	<b>£730.00</b>	<b>£876.00</b>	£912.50	£1,095.00

79-89  
55-65

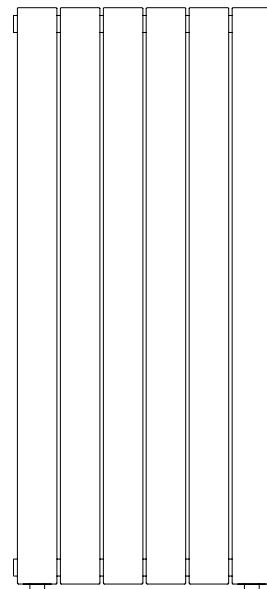

## Stock options White RAL 9016 - Double Vertical

Height (mm)	Width (mm)	Model	Watts Δt 50°C	Btu's Δt 50°C	White Ex VAT	White Inc VAT	Colours Ex VAT	Colours Inc VAT
DELIVERY TIMES					48-72 HOURS		UP TO 5 WEEKS	
1820	160	WATED181602	420	1433	<b>£496.00</b>	<b>£595.20</b>	£620.00	£744.00
	236	WATED182303	630	2150	<b>£589.00</b>	<b>£706.80</b>	£736.25	£883.50
	312	WATED183104	840	2866	<b>£661.00</b>	<b>£793.20</b>	£826.25	£991.50
	388	WATED183805	1050	3583	<b>£769.00</b>	<b>£922.80</b>	£961.25	£1,153.50
	464	WATED184606	1259	4296	<b>£875.00</b>	<b>£1,050.00</b>	£1,093.75	£1,312.50
2020	160	WATED201602	466	1590	<b>£716.00</b>	<b>£859.20</b>	£895.00	£1,074.00
	236	WATED202303	699	2385	<b>£800.00</b>	<b>£960.00</b>	£1,000.00	£1,200.00
	312	WATED203104	932	3180	<b>£891.00</b>	<b>£1,069.20</b>	£1,113.75	£1,336.50
	388	WATED203805	1166	3978	<b>£982.00</b>	<b>£1,178.40</b>	£1,227.50	£1,473.00
	464	WATED204606	1399	4773	<b>£1,108.00</b>	<b>£1,329.60</b>	£1,385.00	£1,662.00

91-101  
67-77

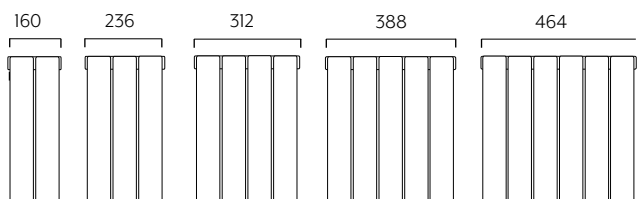
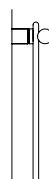

\*Saving based on the value of individual items when bought separately. Order any of our selected valves & matching pipe covers at the same time as your radiator; PROMOV1W (white), PROMOV1C (chrome).



# Immagina shown on page 55

High quality Italian design & manufacture.  
 Steel; optional built in colour changing LED lights with a remote control  
 Supplied with a 12v transformer  
 CE/UKCA approved & certified to BS EN442.



White RAL 9016 as standard, 188 RAL colours plus 30 Special Finishes  
 Please call **01342 302250** for a RAL or Special Finish chart.

Made to Order sizes & colours: Up to 5 weeks.

Pipe centres left to right	Pipe centres from wall	Depth from wall
50mm	57mm - 67mm	115mm - 125mm

Made to order options - Immagina without LED

Height (mm)	Width (mm)	Model	Watts $\Delta t$ 50°C	Btu's $\Delta t$ 50°C	White Ex VAT	White Inc VAT	Colours Ex VAT	Colours Inc VAT
DELIVERY TIMES					UP TO 5 WEEKS		UP TO 5 WEEKS	
1800	500	IMMAI850	769	2624	£3,126.00	£3,751.20	£3,907.50	£4,689.00
2000	600	IMMA2060	1009	3443	£3,647.00	£4,376.40	£4,558.75	£5,470.50

Made to order options - Immagina with LED

Height (mm)	Width (mm)	Model	Watts $\Delta t$ 50°C	Btu's $\Delta t$ 50°C	White Ex VAT	White Inc VAT	Colours Ex VAT	Colours Inc VAT
DELIVERY TIMES					UP TO 5 WEEKS		UP TO 5 WEEKS	
1800	500	IMMLED1850	769	2624	£5,000.00	£6,000.00	£5,781.50	£6,937.80
2000	600	IMMLED2060	1009	3443	£5,521.00	£6,625.20	£6,432.75	£7,719.30

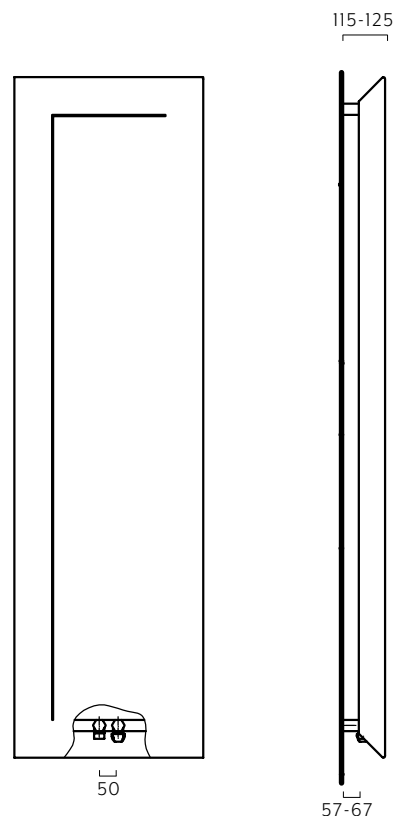

Red LED



Blue LED



Green LED



Remote Control



Supplied with a 12v transformer

# Athena shown on pages 56-57

Steel; Slimline radiator  
CE/UKCA approved & certified to BS EN442.

White RAL 9016 as standard, 188 RAL colours plus 30 Special Finishes  
Please call **01342 302250** for a RAL or Special Finish chart.

## Stock White RAL 9016: 48-72 Hours

Made to Order sizes & colours: Up to 7 weeks for white  
Up to 8 weeks for colours.



Ideal TRV & Pipe Covers



**SAVE £45\***

WHEN YOU BUY OUR IDEAL TRV & PIPE COVERS WITH ANY DESIGNER PURCHASE. QUOTE PROMOV1 AT TIME OF ORDER.

Available in White or Chrome.

Pipe centres left to right	Pipe centres from wall	Depth from wall
width - 70mm	45mm to 53mm	67mm to 75mm

## Stock options White RAL 9016 - Horizontal

Height (mm)	Width (mm)	Model	Watts Δt 50°C	Btu's Δt 50°C	White Ex VAT	White Inc VAT	Colours Ex VAT	Colours Inc VAT
DELIVERY TIMES					48-72 HOURS		UP TO 8 WEEKS	
410	1000	ATHEH4110	392	1338	<b>£626.00</b>	<b>£751.20</b>	£782.50	£939.00
	1200	ATHEH4112	474	1617	<b>£664.00</b>	<b>£796.80</b>	£830.00	£996.00
495	1000	ATHEH4910	460	1570	<b>£659.00</b>	<b>£790.80</b>	£823.75	£988.50
	1200	ATHEH4912	553	1887	<b>£700.00</b>	<b>£840.00</b>	£875.00	£1,050.00

67-75  
45-53

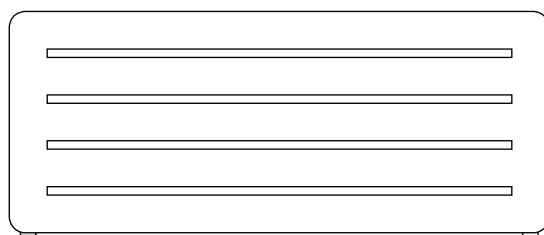
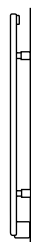

Made to order options - Horizontal

Height (mm)	Width (mm)	Model	Watts Δt 50°C	Btu's Δt 50°C	White Ex VAT	White Inc VAT	Colours Ex VAT	Colours Inc VAT
DELIVERY TIMES					UP TO 7 WEEKS		UP TO 8 WEEKS	
410	1500	ATHEH4115	570	1945	£718.00	£861.60	£897.50	£1,077.00
495	1500	ATHEH4915	694	2368	£761.00	£913.20	£951.25	£1,141.50

## Stock options White RAL 9016 - Vertical

Height (mm)	Width (mm)	Model	Watts Δt 50°C	Btu's Δt 50°C	White Ex VAT	White Inc VAT	Colours Ex VAT	Colours Inc VAT
DELIVERY TIMES					48-72 HOURS		UP TO 8 WEEKS	
1800	410	ATHEV1841	686	2341	<b>£688.00</b>	<b>£825.60</b>	£860.00	£1,032.00
	495	ATHEV1849	837	2856	<b>£717.00</b>	<b>£860.40</b>	£896.25	£1,075.50

67-75  
45-53

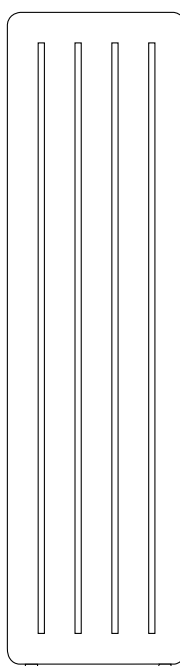

Made to order options - Vertical

Height (mm)	Width (mm)	Model	Watts Δt 50°C	Btu's Δt 50°C	White Ex VAT	White Inc VAT	Colours Ex VAT	Colours Inc VAT
DELIVERY TIMES					UP TO 7 WEEKS		UP TO 8 WEEKS	
1500	410	ATHEV1541	575	1962	£660.00	£792.00	£825.00	£990.00
	495	ATHEV1549	697	2378	£691.00	£829.20	£863.75	£1,036.50

\*Saving based on the value of individual items when bought separately. Order any of our selected valves & matching pipe covers at the same time as your radiator; PROMOV1W (white), PROMOV1C (chrome).

# Halo shown on page 60-61

High quality Italian design & manufacture.  
Steel; 87mm, 133mm, 155mm 180mm & 187mm fins  
CE/UKCA approved & certified to BS EN442.

Matt White RAL 9016 as standard, 188 RAL colours plus 2 Special Finishes; Metallic Silver & Matt Black. Please call **01342 302250** for a RAL chart.

Made to Order sizes & colours: Up to 7 weeks for white  
Up to 7 weeks for colours, 9 weeks for chrome.



**Ideal TRV & Pipe Covers**



**SAVE £45\***  
WHEN YOU BUY OUR IDEAL TRV & PIPE COVERS WITH ANY DESIGNER PURCHASE. QUOTE PROMOV1 AT TIME OF ORDER.

Available in White or Chrome.

Halo Horizontal	Pipe centres left to right	Pipe centres from wall
Halo 130mm	width + valves	minimum of 65mm
Halo 190mm	width + valves	minimum of 90mm
Halo 250mm	width + valves	minimum of 120mm

## Made to order options - Horizontal White & Colours

Height (mm)	Width (mm)	Model	Watts Δt 50°C	BTU's Δt 50°C	Matt White Ex VAT	Matt White Inc VAT	Colour & Finishes Ex VAT	Colour & Finishes Inc VAT
DELIVERY TIMES			UP TO 7 WEEKS		UP TO 7 WEEKS		UP TO 7 WEEKS	
130	1000	HALOI310	269	918	£949.00	£1138.80	£1,138.80	£1,366.56
	1500	HALOI315	413	1409	£1,029.00	£1,234.80	£1,234.80	£1,481.76
	2000	HALOI320	557	1900	£1,107.00	£1,328.40	£1,328.40	£1,594.08
190	1000	HALOI910	401	1368	£1,156.00	£1,387.20	£1,387.20	£1,664.64
	1500	HALOI915	616	2102	£1,264.00	£1,516.80	£1,516.80	£1,820.16
	2000	HALOI920	831	2835	£1,399.00	£1,678.80	£1,678.80	£2,014.56
250	1000	HALO2510	993	3388	£1,177.00	£1,412.40	£1,412.40	£1,694.88
	1500	HALO2515	1490	5084	£1,492.00	£1,790.40	£1,790.40	£2,148.48
	2000	HALO2520	1969	6718	£1,949.00	£2,338.80	£2,338.80	£2,806.56

## Made to order options - Horizontal Chrome

Height (mm)	Width (mm)	Model	Watts Δt 50°C	BTU's Δt 50°C	Chrome Ex VAT	Chrome Inc VAT
DELIVERY TIMES			UP TO 9 WEEKS			
190	1000	HALOI910C	353	1204	£1,276.00	£1,531.20
	1500	HALOI915C	542	1849	£1,428.00	£1,713.60
	2000	HALOI920C	731	2494	£1,756.00	£2,107.20
250	1000	HALO2510C	874	2982	£1,422.00	£1,706.40
	1500	HALO2515C	1311	4473	£2,130.00	£2,556.00
	2000	HALO2520C	1733	5913	£2,842.00	£3,410.40

## Made to order options - Horizontal Electric

Height (mm)	Width (mm)	Model	Watts Δt 50°C	Matt White Ex VAT	Matt White Inc VAT	Colour & Finishes Ex VAT	Colour & Finishes Inc VAT	Chrome Ex VAT	Chrome Inc VAT
DELIVERY TIMES			UP TO 7 WEEKS		UP TO 7 WEEKS		UP TO 9 WEEKS		
180	1015	HALOE1810	500	£1,397.00	£1,676.40	£1,676.40	£2,011.68	£1,643.00	£1,971.60
	1515	HALOE1815	750	£1,600.00	£1,920.00	£1,920.00	£2,304.00	£2,042.00	£2,450.40
	2015	HALOE1820	1000	£1,772.00	£2,126.40	£2,126.40	£2,551.68	£2,581.00	£3,097.20

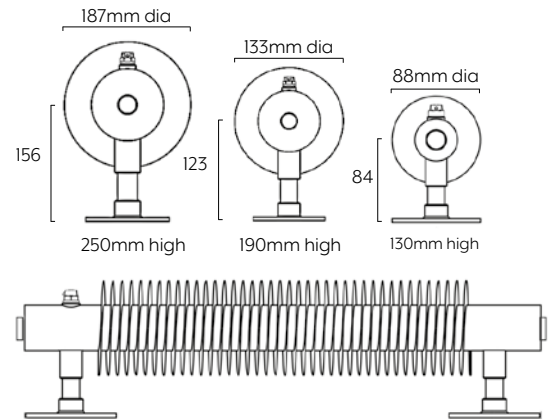

Halo Vertical	Pipe centres left to right	Pipe centres from wall	Depth from wall
Halo 155mm	60mm	148mm	225mm

## Made to order options - Vertical White & Colours

Height (mm)	Width (mm)	Model	Watts Δt 50°C	BTU's Δt 50°C	Matt White Ex VAT	Matt White Inc VAT	Colour & Finishes Ex VAT	Colour & Finishes Inc VAT
DELIVERY TIMES			UP TO 7 WEEKS		UP TO 7 WEEKS		UP TO 7 WEEKS	
1500	155	HALOV1515	865	2951	£1,646.00	£1,975.20	£1,975.20	£2,370.24
1800	155	HALOV1815	1040	3548	£1,799.00	£2,158.80	£2,158.80	£2,590.56
2000	155	HALOV2015	1153	3934	£1,863.00	£2,235.60	£2,235.60	£2,682.72

## Made to order options - Vertical Chrome

Height (mm)	Width (mm)	Model	Watts Δt 50°C	BTU's Δt 50°C	Chrome Ex VAT	Chrome Inc VAT
DELIVERY TIMES			UP TO 9 WEEKS			
1500	155	HALOV1515C	761	2597	£2,219.00	£2,662.80
1800	155	HALOV1815C	915	3122	£2,694.00	£3,232.80
2000	155	HALOV2015C	1015	3463	£2,996.00	£3,595.20

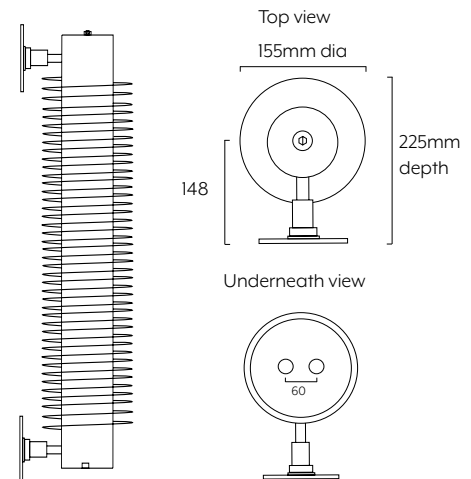

\*Saving based on the value of individual items when bought separately. Order any of our selected valves & matching pipe covers at the same time as your radiator; PROMOV1W (white), PROMOV1C (chrome).

# Relax Horizontal shown on page 58

High quality Italian design & manufacture.

Steel; Slimline round tube on tube radiator cloaked in a steel cover  
CE/UKCA approved & certified to BS EN442.

White RAL 9016 as standard, 188 RAL colours plus 30 Special Finishes

Please call **01342 302250** for a RAL or Special Finish chart.

## Stock White RAL 9016: 48-72 Hours

Made to Order sizes & colours: Up to 5 weeks.



**Ideal TRV & Pipe Covers**



**SAVE £45\***  
WHEN YOU BUY OUR IDEAL TRV & PIPE COVERS WITH ANY DESIGNER PURCHASE. QUOTE PROMOV1 AT TIME OF ORDER.

Available in White or Chrome.

Relax horizontal	Pipe centres left to right	Pipe centres from wall	Depth from wall
Single horizontal	width - 109mm	55mm	88mm

## Stock options White RAL 9016 - Single Horizontal

Height (mm)	Width (mm)	Model	Watts Δt 50°C	Btu's Δt 50°C	White Ex VAT	White Inc VAT	Colours Ex VAT	Colours Inc VAT
DELIVERY TIMES					48-72 HOURS		UP TO 5 WEEKS	
478	1197	RELASH4711	665	2269	£887.00	£1,064.40	£1,108.75	£1,330.50
578	1197	RELASH5711	824	2811	£914.00	£1,096.80	£1,142.50	£1,371.00

Made to order options - Single Horizontal

Height (mm)	Width (mm)	Model	Watts Δt 50°C	Btu's Δt 50°C	White Ex VAT	White Inc VAT	Colours Ex VAT	Colours Inc VAT
DELIVERY TIMES					UP TO 5 WEEKS		UP TO 5 WEEKS	
478	1401	RELASH4714	783	2672	£981.00	£1,177.20	£1,226.25	£1,471.50
	1809	RELASH4718	1019	3477	£1,272.00	£1,526.40	£1,590.00	£1,908.00
	2013	RELASH4720	1137	3879	£1,401.00	£1,681.20	£1,751.25	£2,101.50
578	1401	RELASH5714	970	3310	£1,008.00	£1,209.60	£1,260.00	£1,512.00
	1809	RELASH5718	1262	4306	£1,310.00	£1,572.00	£1,637.50	£1,965.00
	2013	RELASH5720	1408	4804	£1,442.00	£1,730.40	£1,802.50	£2,163.00

Single



Relax horizontal	Pipe centres left to right	Pipe centres from wall	Depth from wall
Double horizontal	width - 109mm	79mm to 89mm	112mm to 122mm

## Stock options White RAL 9016 - Double Horizontal

Height (mm)	Width (mm)	Model	Watts Δt 50°C	Btu's Δt 50°C	White Ex VAT	White Inc VAT	Colours Ex VAT	Colours Inc VAT
DELIVERY TIMES					48-72 HOURS		UP TO 5 WEEKS	
478	1197	RELADH4711	1045	3566	£1,079.00	£1,294.80	£1,348.75	£1,618.50
578	1197	RELADH5711	1294	4415	£1,174.00	£1,408.80	£1,467.50	£1,761.00

Made to order options - Double Horizontal

Height (mm)	Width (mm)	Model	Watts Δt 50°C	Btu's Δt 50°C	White Ex VAT	White Inc VAT	Colours Ex VAT	Colours Inc VAT
DELIVERY TIMES					UP TO 5 WEEKS		UP TO 5 WEEKS	
478	1401	RELADH4714	1231	4200	£1,167.00	£1,400.40	£1,458.75	£1,750.50
	1809	RELADH4718	1602	5466	£1,517.00	£1,820.40	£1,896.25	£2,275.50
	2013	RELADH4720	1787	6097	£1,669.00	£2,002.80	£2,086.25	£2,503.50
578	1401	RELADH5714	1524	5200	£1,282.00	£1,538.40	£1,602.50	£1,923.00
	1809	RELADH5718	1983	6766	£1,665.00	£1,998.00	£2,081.25	£2,497.50
	2013	RELADH5720	2213	7551	£1,834.00	£2,200.80	£2,292.50	£2,751.00

Double

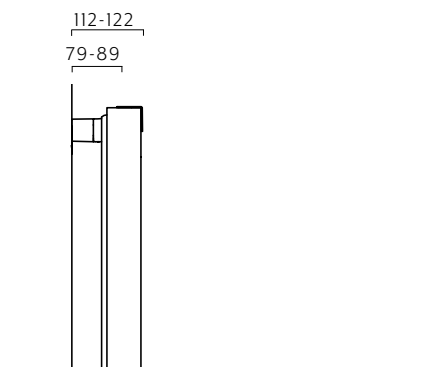

\*Saving based on the value of individual items when bought separately. Order any of our selected valves & matching pipe covers at the same time as your radiator; PROMOV1W (white), PROMOV1C (chrome).

# Relax Vertical shown on page 59

High quality Italian design & manufacture.

Steel; Slimline round tube on tube radiator cloaked in a steel cover  
CE/UKCA approved & certified to BS EN442.

White RAL 9016 as standard, 188 RAL colours plus 30 Special Finishes  
Please call **01342 302250** for a RAL or Special Finish chart.

## Stock White RAL 9016: 48-72 Hours

Made to Order sizes & colours: Up to 5 weeks for white & colours  
Up to 8 weeks for Polished Stainless Steel.

Relax vertical	Pipe centres left to right	Pipe centres from wall	Depth from wall
Single vertical	width - 109mm	55mm	88mm



Ideal TRV & Pipe Covers



**SAVE £45\***  
WHEN YOU BUY OUR IDEAL TRV & PIPE COVERS WITH ANY DESIGNER PURCHASE. QUOTE PROMOV1 AT TIME OF ORDER.

Available in White or Chrome.

## Stock options White RAL 9016 - Single Vertical

Height (mm)	Width (mm)	Model	Watts Δt 50°C	Btu's Δt 50°C	White Ex VAT	White Inc VAT	Colours Ex VAT	Colours Inc VAT
DELIVERY TIMES					48-72 HOURS		UP TO 5 WEEKS	
1853	517	RELASV1851	1178	4019	£1,109.00	£1,330.80	£1,386.25	£1,663.50
	653	RELASV1865	1519	5183	£1,209.00	£1,450.80	£1,511.25	£1,813.50

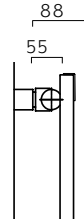

Made to order options - Inox Single Vertical

Height (mm)	Width (mm)	Model	Watts Δt 50°C	Btu's Δt 50°C	Polished Stainless Steel Ex VAT	Polished Stainless Steel Inc VAT
DELIVERY TIMES					UP TO 8 WEEKS	
1553	381	REINSV1538	489	1668	£2,253.00	£2,703.60
	517	REINSV1551	689	2351	£2,401.00	£2,881.20
	653	REINSV1565	888	3030	£2,505.00	£3,006.00
1853	381	REINSV1838	586	1999	£2,665.00	£3,198.00
	517	REINSV1851	825	2815	£2,922.00	£3,506.40
	653	REINSV1865	1063	3627	£3,126.00	£3,751.20
2053	381	REINSV2038	650	2218	£2,814.00	£3,376.80
	517	REINSV2051	915	3122	£3,126.00	£3,751.20
	653	REINSV2065	1180	4026	£3,334.00	£4,000.80

Made to order options - Single Vertical

Height (mm)	Width (mm)	Model	Watts Δt 50°C	Btu's Δt 50°C	White Ex VAT	White Inc VAT	Colours Ex VAT	Colours Inc VAT
DELIVERY TIMES					UP TO 5 WEEKS		UP TO 5 WEEKS	
1553	381	RELASV1538	699	2385	£811.00	£973.20	£1,013.75	£1,216.50
	517	RELASV1551	984	3357	£923.00	£1,107.60	£1,153.75	£1,384.50
	653	RELASV1565	1269	4330	£1,014.00	£1,216.80	£1,267.50	£1,521.00
1853	381	RELASV1838	837	2856	£882.00	£1,058.40	£1,102.50	£1,323.00

Relax vertical	Pipe centres left to right	Pipe centres from wall	Depth from wall
Double vertical	width - 109mm	79mm - 89mm	112mm - 122mm

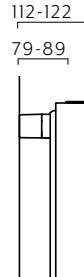

## Stock options White RAL 9016 - Double Vertical

Height (mm)	Width (mm)	Model	Watts Δt 50°C	Btu's Δt 50°C	White Ex VAT	White Inc VAT	Colours Ex VAT	Colours Inc VAT
DELIVERY TIMES					48-72 HOURS		UP TO 5 WEEKS	
1853	517	RELADV1851	1477	5040	£1,395.00	£1,674.00	£1,743.75	£2,092.50
	653	RELADV1865	1817	6200	£1,711.00	£2,053.20	£2,138.75	£2,566.50

Made to order options - Double Vertical

Height (mm)	Width (mm)	Model	Watts Δt 50°C	Btu's Δt 50°C	White Ex VAT	White Inc VAT	Colours Ex VAT	Colours Inc VAT
DELIVERY TIMES					UP TO 5 WEEKS		UP TO 5 WEEKS	
1553	381	RELADV1538	1017	3470	£1,089.00	£1,306.80	£1,361.25	£1,633.50
	517	RELADV1551	1431	4883	£1,195.00	£1,434.00	£1,493.75	£1,792.50
	653	RELADV1565	1591	5428	£1,295.00	£1,554.00	£1,618.75	£1,942.50
1853	381	RELADV1838	1050	3583	£1,167.00	£1,400.40	£1,458.75	£1,750.50

Made to order options - Inox Double Vertical

Height (mm)	Width (mm)	Model	Watts Δt 50°C	Btu's Δt 50°C	Polished Stainless Steel Ex VAT	Polished Stainless Steel Inc VAT
DELIVERY TIMES					UP TO 8 WEEKS	
1553	381	REINDV1538	712	2429	£3,113.00	£3,735.60
	517	REINDV1551	1002	3419	£3,221.00	£3,865.20
	653	REINDV1565	1114	3801	£3,435.00	£4,122.00
1853	381	REINDV1838	735	2508	£3,654.00	£4,384.80
	517	REINDV1851	1034	3528	£3,978.00	£4,773.60
	653	REINDV1865	1272	4340	£4,188.00	£5,025.60
2053	381	REINDV2038	778	2655	£3,869.00	£4,642.80
	517	REINDV2051	1095	3736	£4,254.00	£5,104.80
	653	REINDV2065	1397	4767	£4,514.00	£5,416.80

\*Saving based on the value of individual items when bought separately. Order any of our selected valves & matching pipe covers at the same time as your radiator; PROMOV1W (white), PROMOV1C (chrome).

# Sectional Stocked Aluminium

All our sectional aluminium is held in stock in the UK. White product can be delivered in 48-72 hours and coloured orders will be finished and delivered in up to 3 weeks. Our most popular sizes are listed in the price tables, for other sizes use our online radiator builder or follow the instructions below to specify your radiator.

## Choose your radiator using our online radiator builder

Once you know your outputs use our **online radiator builder** to select the best solution for your room. It will take you through the process quickly and easily and allows you to save your ideas to your own Wish List. Go to our **NEW** website **theradiatorcompany.co.uk**

It is vital to know the correct heat output you need to keep your room warm, use our online Heat Output Calculator to get a guide to your requirements which you can then check with your installer.

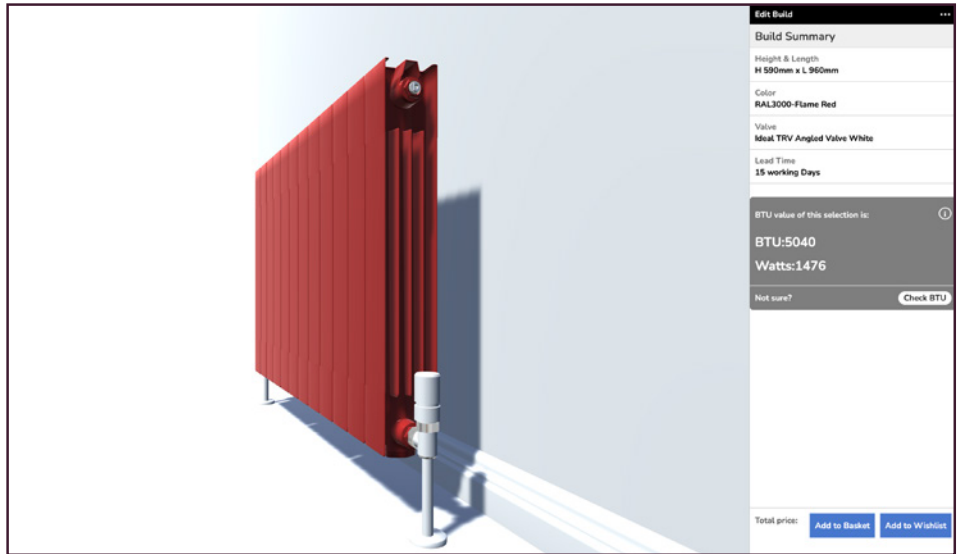

Once you know your outputs you can also use the brochure to specify your radiator by following these steps (or call our Customer Services team on 01342 302250 who will help you size your radiator)

Note the space you have in mind for the radiator(s) you need; vertical or horizontal, length, height & depth

- Select a column option and height that fits your space; Calculate the number of Sections you need by dividing the required BTU (Watt) output with the output per section; e.g  $4811 \text{ BTUs} \div 420 = 11.45$ , (we always suggest rounding up, as it is better to have too much output, than too little) therefore 12 sections based on Vip 590
- If using that section size does work in the space available, try a different height or alternative aluminium profile
- Once you have calculated the best number and size of section, select your colour. Our Aluminium Radiators are available in a selection of the top 23 most popular colours from the RAL range and 30 Special Finishes (shown on pages 63 & 216). Please specify your RAL colour or special finish at time of order. White RAL 9010 is our standard for the Vip, Oscar, Vox and Mix
- Work out the price of your radiator by multiplying the section price by the total number of sections e.g  $Vip \ 590 \text{ high, } 12 \text{ sections in RAL } 3000 - \text{Flame Red} = £76.72 \times 12 = £920.64 \text{ (inc VAT)}$
- Place your order by using the Sectional Model Code x No. of Sections needed and noting the colour number and name selected; e.g  $VIP59 \times 12 \text{ in RAL } 3000$
- If you have chosen a colour make sure you list the colour number and name

All prices and outputs are given per section in the tables on pages 175-183. Price per section includes plugs, bushes and diverter.

End Panels for the Vip & Oscar must be specified at time of order, please see page 175 for more information.

## Aluminium Colours

All our Sectional Aluminium radiators are available in a selection of the top 23 most popular colours from the RAL range as well as 30 exclusive special finishes. These radiators provide both the efficiencies of aluminium and a stunning finish.

Available in up to 3 weeks. Please call **01342 302250** for a RAL or Special Finish chart.

For orders of more than 10 radiators in colour or special finishes please allow an extra 10 working days for delivery.

## Feature Finishes

Painted in the UK, these 3 new Feature Finishes give a personal touch to any room. They join our existing range, giving 6 exciting options to choose from. Vintage Green, Satin Gold and Aged Brass sit alongside Textured Anthracite, Copper and Pearl Bronze. See page 14 for full details. Please call customer services for sample swatches.

New



## Colour Coordination Service

Available for all sectional aluminium, see product pages 217 for full details including process & lead times.



# Aluminium Accessories

## Hanging Bars & Pegs

These towel bars and pegs are designed to fit all of our sectional aluminium ranges. Ideal for providing additional hanging space to air towels or hang bathrobes. **Available from stock in 48-72 hours.**

Description/ Suitable for	Model	White Ex VAT	White Inc VAT	Chrome Ex VAT	Chrome Inc VAT
DELIVERY TIMES		48-72 HOURS			
Peg / Vip, Mix, Vox, Oscar	AAHPEG01	£29.00	£34.80	£35.00	£42.00
Bar 480mm / Vip, Mix, Vox, Oscar	AAHBAR01	£84.00	£100.80	£103.00	£123.60
Bar 320mm / Vip, Mix, Vox, Oscar	AAHBAR02	£84.00	£100.80	£103.00	£123.60

320mm Towel Bars need a minimum of 6 sections to fit

480mm Towel Bars need a minimum of 8 sections to fit

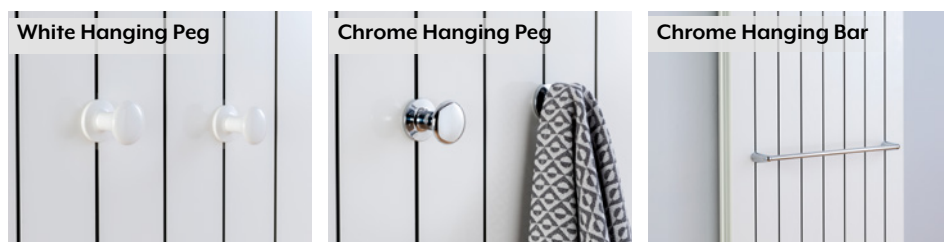

A nominal £5 charge for postage and packing will be applied to any orders under £50 in value

White Hanging Bar



## Complete the look with End Panels

### Vip End Panels stock options RAL 9010

Height (mm)	Model	White Ex VAT	White Inc VAT	RAL Colours Ex VAT	RAL Colours Inc VAT	Special & Feature Finishes Ex VAT	Special & Feature Finishes Inc VAT
DELIVERY TIMES		48-72 HOURS		UP TO 3 WEEKS		UP TO 3 WEEKS	
440	VIPEP44	£67.00	£80.40	£98.49	£118.19	£105.86	£127.03
590	VIPEP59	£76.00	£91.20	£111.72	£134.06	£120.08	£144.10
690	VIPEP69	£82.00	£98.40	£120.54	£144.65	£129.56	£155.47
790	VIPEP79	£84.00	£100.80	£123.48	£148.18	£132.72	£159.26

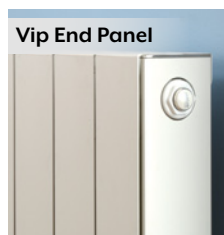

Please specify at time of order if you would like End Panels with your Vip radiator

### Oscar End Panels stock options RAL 9010

Height (mm)	Model	White Ex VAT	White Inc VAT	RAL Colours Ex VAT	RAL Colours Inc VAT	Special & Feature Finishes Ex VAT	Special & Feature Finishes Inc VAT
DELIVERY TIMES		48-72 HOURS		UP TO 3 WEEKS		UP TO 3 WEEKS	
1046	OSCAEP10	£106.00	£127.20	£154.76	£185.71	£167.48	£200.98
1246	OSCAEP12	£109.00	£130.80	£159.14	£190.97	£172.22	£206.66
1446	OSCAEP14	£118.00	£141.60	£172.28	£206.74	£186.44	£223.73
1646	OSCAEP16	£136.00	£163.20	£198.56	£238.27	£214.88	£257.86
1846	OSCAEP18	£140.00	£168.00	£204.40	£245.28	£221.20	£265.44
2046	OSCAEP20	£146.00	£175.20	£213.16	£255.79	£230.68	£276.82

Please specify at time of order if you would like End Panels with your Oscar radiator

## Joining Key

Joining Keys are available on a sale or return basis. Joining Keys must be specified at time of order. For assistance please contact our Customer Service team on **01342 302250**, they will also arrange a courier to collect it from you when you are ready.

Description/ Suitable for	Model	Price Ex VAT	Price Inc VAT
DELIVERY TIMES		48-72 HOURS	
Joining Key 1" x 300mm/600mm/900mm	PPASM	£557.00	£668.40











High quality Italian design & manufacture.  
Sectional Aluminium. CE/UKCA approved & certified to BS EN442.

White RAL 9010 as standard, 23 RAL colours plus 30 Special Finishes & 6 new Feature Finishes. Please call **01342 302250** for a RAL or Special Finish chart  
Colour Coordination Service available on stock sizes see page 217 for full details.

**Stock White RAL 9010: 48-72 Hours**

Colours & Special / Feature Finishes: Up to 3 weeks (please allow up to 5 weeks for orders of more than 10 radiators in colours or special/ feature finishes).

Choose from our assembled stock options or build your own size by individual section, visit **theradiatorcompany.co.uk** to use our radiator builder.



**Ideal TRV & Pipe Covers**



**SAVE £45\***  
WHEN YOU BUY OUR IDEAL TRV & PIPE COVERS WITH ANY DESIGNER PURCHASE. QUOTE PROMOV1 AT TIME OF ORDER.

Available in White or Chrome.

**Assembled stock options RAL 9010**

1046mm High

Height (mm)	Width (mm)	Sections	Model	Watts Δt 50°C	Btu's Δt 50°C	White Ex VAT	White Inc VAT	RAL Colours	RAL Colours	Special & Feature Finishes	
								Ex VAT	Inc VAT	Ex VAT	Inc VAT
DELIVERY TIMES						<b>48-72 HOURS</b>		UP TO 3 WEEKS		UP TO 3 WEEKS	
1046	260	3	OSCASI0X3	570	1945	<b>£227.40</b>	<b>£272.88</b>	£320.64	£384.77	£343.38	£412.06
	340	4	OSCASI0X4	760	2593	<b>£303.20</b>	<b>£363.84</b>	£427.52	£513.02	£457.84	£549.41
	420	5	OSCASI0X5	950	3241	<b>£379.00</b>	<b>£454.80</b>	£534.40	£641.28	£572.30	£686.76
	500	6	OSCASI0X6	1140	3890	<b>£454.80</b>	<b>£545.76</b>	£641.28	£769.54	£686.76	£824.11
	580	7	OSCASI0X7	1330	4538	<b>£530.60</b>	<b>£636.72</b>	£748.16	£897.79	£801.22	£961.46
	660	8	OSCASI0X8	1520	5186	<b>£606.40</b>	<b>£727.68</b>	£855.04	£1,026.05	£915.68	£1,098.82
	740	9	OSCASI0X9	1710	5835	<b>£682.20</b>	<b>£818.64</b>	£961.92	£1,154.30	£1,030.14	£1,236.17
	820	10	OSCASI0X10	1900	6483	<b>£758.00</b>	<b>£909.60</b>	£1,068.80	£1,282.56	£1,144.60	£1,373.52

Widths include measurement for bushes

Quoted prices include plugs, bushes, air vent and wall brackets but excludes end panels.

Optional end panels available, please specify at time of order, see page 175 for prices.

23 RAL colours are shown on page 216

1246mm High

Height (mm)	Width (mm)	Sections	Model	Watts Δt 50°C	Btu's Δt 50°C	White Ex VAT	White Inc VAT	RAL Colours	RAL Colours	Special & Feature Finishes	
								Ex VAT	Inc VAT	Ex VAT	Inc VAT
DELIVERY TIMES						<b>48-72 HOURS</b>		UP TO 3 WEEKS		UP TO 3 WEEKS	
1246	260	3	OSCASI2X3	654	2231	<b>£296.13</b>	<b>£355.36</b>	£417.54	£501.05	£447.15	£536.58
	340	4	OSCASI2X4	872	2975	<b>£394.84</b>	<b>£473.81</b>	£556.72	£668.06	£596.20	£715.44
	420	5	OSCASI2X5	1090	3719	<b>£493.55</b>	<b>£592.26</b>	£695.90	£835.08	£745.25	£894.30
	500	6	OSCASI2X6	1308	4463	<b>£592.26</b>	<b>£710.71</b>	£835.08	£1,002.10	£894.30	£1,073.16
	580	7	OSCASI2X7	1526	5207	<b>£690.97</b>	<b>£829.16</b>	£974.26	£1,169.11	£1,043.35	£1,252.02
	660	8	OSCASI2X8	1744	5951	<b>£789.68</b>	<b>£947.62</b>	£1,113.44	£1,336.13	£1,192.40	£1,430.88
	740	9	OSCASI2X9	1962	6694	<b>£888.39</b>	<b>£1,066.07</b>	£1,252.62	£1,503.14	£1,341.45	£1,609.74
	820	10	OSCASI2X10	2180	7438	<b>£987.10</b>	<b>£1,184.52</b>	£1,391.80	£1,670.16	£1,490.50	£1,788.60

23 RAL colours are shown on page 216

1446mm High

Height (mm)	Width (mm)	Sections	Model	Watts Δt 50°C	Btu's Δt 50°C	White Ex VAT	White Inc VAT	RAL Colours	RAL Colours	Special & Feature Finishes	
								Ex VAT	Inc VAT	Ex VAT	Inc VAT
DELIVERY TIMES						<b>48-72 HOURS</b>		UP TO 3 WEEKS		UP TO 3 WEEKS	
1446	260	3	OSCASI4X3	735	2508	<b>£365.82</b>	<b>£438.98</b>	£515.82	£618.98	£552.39	£662.87
	340	4	OSCASI4X4	980	3344	<b>£487.76</b>	<b>£585.31</b>	£687.76	£825.31	£736.52	£883.82
	420	5	OSCASI4X5	1225	4180	<b>£609.70</b>	<b>£731.64</b>	£859.70	£1,031.64	£920.65	£1,104.78
	500	6	OSCASI4X6	1470	5016	<b>£731.64</b>	<b>£877.97</b>	£1,031.64	£1,237.97	£1,104.78	£1,325.74
	580	7	OSCASI4X7	1715	5852	<b>£853.58</b>	<b>£1,024.30</b>	£1,203.58	£1,444.30	£1,288.91	£1,546.69
	660	8	OSCASI4X8	1960	6688	<b>£975.52</b>	<b>£1,170.62</b>	£1,375.52	£1,650.62	£1,473.04	£1,767.65
	740	9	OSCASI4X9	2205	7523	<b>£1,097.46</b>	<b>£1,316.95</b>	£1,547.46	£1,856.95	£1,657.17	£1,988.60
	820	10	OSCASI4X10	2450	8359	<b>£1,219.40</b>	<b>£1,463.28</b>	£1,719.40	£2,063.28	£1,841.30	£2,209.56

23 RAL colours are shown on page 216

OSCA10X6 - 1046mm x 500mm

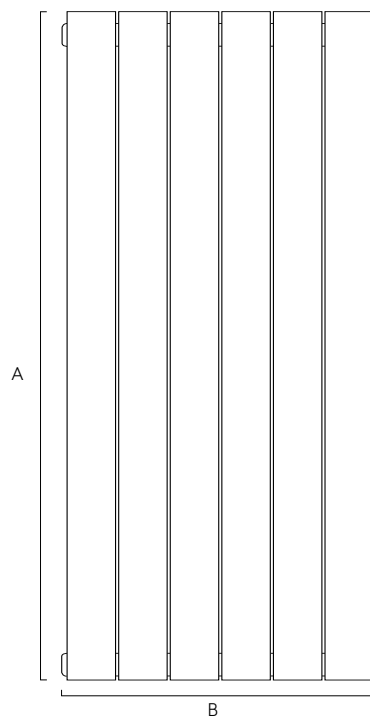

Pipe centres left to right	Pipe centres from wall	Depth from wall
width + valves	67mm to 71mm	114mm to 118mm

Optional end panels available for Oscar range, see page 175 for more information and pricing.

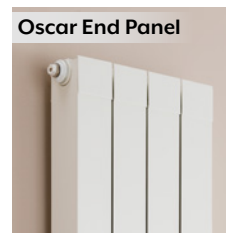

Please specify at time of order

\*Saving based on the value of individual items when bought separately. Order any of our selected valves & matching pipe covers at the same time as your radiator; PROMOV1W (white), PROMOV1C (chrome).

## Assembled stock options RAL 9010

1646mm High

Height (mm)	Width (mm)	Sections	Model	Watts Δt 50°C	Btu's Δt 50°C	White Ex VAT	White Inc VAT	RAL Colours Ex VAT	RAL Colours Inc VAT	Special & Feature Finishes Ex VAT	Special & Feature Finishes Inc VAT
DELIVERY TIMES						48-72 HOURS		UP TO 3 WEEKS		UP TO 3 WEEKS	
1646	260	3	OSCASI6X3	813	2774	£403.65	£484.38	£569.16	£682.99	£609.51	£731.41
	340	4	OSCASI6X4	1084	3699	£538.20	£645.84	£758.88	£910.66	£812.68	£975.22
	420	5	OSCASI6X5	1355	4623	£672.75	£807.30	£948.60	£1,138.32	£1,015.85	£1,219.02
	500	6	OSCASI6X6	1626	5548	£807.30	£968.76	£1,138.32	£1,365.98	£1,219.02	£1,462.82
	580	7	OSCASI6X7	1897	6473	£941.85	£1,130.22	£1,328.04	£1,593.65	£1,422.19	£1,706.63
	660	8	OSCASI6X8	2168	7397	£1,076.40	£1,291.68	£1,517.76	£1,821.31	£1,625.36	£1,950.45
	740	9	OSCASI6X9	2439	8322	£1,210.95	£1,453.14	£1,707.48	£2,048.98	£1,828.53	£2,194.24
	820	10	OSCASI6X10	2710	9247	£1,345.50	£1,614.60	£1,897.20	£2,276.64	£2,031.70	£2,438.04

23 RAL colours are shown on page 216

1846mm High

Height (mm)	Width (mm)	Sections	Model	Watts Δt 50°C	Btu's Δt 50°C	White Ex VAT	White Inc VAT	RAL Colours Ex VAT	RAL Colours Inc VAT	Special & Feature Finishes Ex VAT	Special & Feature Finishes Inc VAT
DELIVERY TIMES						48-72 HOURS		UP TO 3 WEEKS		UP TO 3 WEEKS	
1846	260	3	OSCASI8X3	891	3040	£442.92	£531.50	£624.51	£749.41	£668.82	£802.58
	340	4	OSCASI8X4	1188	4053	£590.56	£708.67	£832.68	£999.22	£891.76	£1,070.11
	420	5	OSCASI8X5	1485	5067	£738.20	£885.84	£1,040.85	£1,249.02	£1,114.70	£1,337.64
	500	6	OSCASI8X6	1782	6080	£885.84	£1,063.01	£1,249.02	£1,498.82	£1,337.64	£1,605.17
	580	7	OSCASI8X7	2079	7094	£1,033.48	£1,240.18	£1,457.19	£1,748.63	£1,560.58	£1,872.70
	660	8	OSCASI8X8	2376	8107	£1,181.12	£1,417.34	£1,665.36	£1,998.43	£1,783.52	£2,140.22
	740	9	OSCASI8X9	2673	9120	£1,328.76	£1,594.51	£1,873.53	£2,248.24	£2,006.46	£2,407.75
	820	10	OSCASI8X10	2970	10134	£1,476.40	£1,771.68	£2,081.70	£2,498.04	£2,229.40	£2,675.28

23 RAL colours are shown on page 216

2046mm High

Height (mm)	Width (mm)	Sections	Model	Watts Δt 50°C	Btu's Δt 50°C	White Ex VAT	White Inc VAT	RAL Colours Ex VAT	RAL Colours Inc VAT	Special & Feature Finishes Ex VAT	Special & Feature Finishes Inc VAT
DELIVERY TIMES						48-72 HOURS		UP TO 3 WEEKS		UP TO 3 WEEKS	
2046	260	3	OSCAS20X3	963	3286	£497.73	£597.28	£701.79	£842.15	£751.56	£901.87
	340	4	OSCAS20X4	1284	4381	£663.64	£796.37	£935.72	£1,122.86	£1,002.08	£1,202.50
	420	5	OSCAS20X5	1605	5476	£829.55	£995.46	£1,169.65	£1,403.58	£1,252.60	£1,503.12
	500	6	OSCAS20X6	1926	6572	£995.46	£1,194.55	£1,403.58	£1,684.30	£1,503.12	£1,803.74
	580	7	OSCAS20X7	2247	7667	£1,161.37	£1,393.64	£1,637.51	£1,965.01	£1,753.64	£2,104.37
	660	8	OSCAS20X8	2568	8762	£1,327.28	£1,592.74	£1,871.44	£2,245.73	£2,004.16	£2,404.99
	740	9	OSCAS20X9	2889	9857	£1,493.19	£1,791.83	£2,105.37	£2,526.44	£2,254.68	£2,705.62
	820	10	OSCAS20X10	3210	10953	£1,659.10	£1,990.92	£2,339.30	£2,807.16	£2,505.20	£3,006.24

23 RAL colours are shown on page 216

## Stock options by section RAL 9010

Outputs & price given per section, see page 174 for help on sizing your radiator or visit [theradiatorcompany.co.uk](http://theradiatorcompany.co.uk) where you will find our radiator builder.

Height (mm)	Width (mm)	Model	Watts Δt 50°C	Btu's Δt 50°C	White Ex VAT	White Inc VAT	RAL Colours Ex VAT	RAL Colours Inc VAT	Special & Feature Finishes Ex VAT	Special & Feature Finishes Inc VAT	
DELIVERY TIMES						48-72 HOURS		UP TO 3 WEEKS		UP TO 3 WEEKS	
1046	80	OSCAI0	190	648	£75.80	£90.96	£106.88	£128.26	£114.46	£137.35	
1246		OSCAI2	218	744	£98.71	£118.45	£139.18	£167.02	£149.05	£178.86	
1446		OSCAI4	245	836	£121.94	£146.33	£171.94	£206.33	£184.13	£220.96	
1646		OSCAI6	271	925	£134.55	£161.46	£189.72	£227.66	£203.17	£243.80	
1846		OSCAI8	297	1013	£147.64	£177.17	£208.17	£249.80	£222.94	£267.53	
2046		OSCA20	321	1095	£165.91	£199.09	£233.93	£280.72	£250.52	£300.62	

23 RAL colours are shown on page 216

Note: Supplied pre-assembled in up to 10 sections (800mm), wider radiators must be joined on site.

Pipe centres left to right	Pipe centres from wall	Depth from wall
no. of sections x 80mm + 20mm bushes + valves	67mm to 71mm	114mm to 118mm

Widths include measurement for bushes

Quoted prices include plugs, bushes, air vent and wall brackets but excludes end panels.

Optional end panels available, please specify at time of order, see page 175 for prices.

Pipe centres left to right	Pipe centres from wall	Depth from wall
width + valves	67mm to 71mm	114mm to 118mm

Optional end panels available for Oscar range, see page 175 for more information and pricing



### Feature Finishes

Please call customer services for sample swatches.

Copper

Textured Anthracite

Vintage Green

Aged Brass

New

95

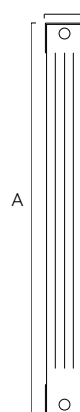

Optional end panels available for Oscar range, see page 175 for more information and pricing.

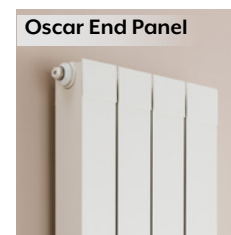

Please specify at time of order



High quality Italian design & manufacture.  
Sectional Aluminium. CE/UKCA approved & certified to BS EN442.

White RAL 9010 as standard, 23 RAL colours plus 30 Special Finishes & 6 Feature Finishes. Please call **01342 302250** for a RAL or Special Finish chart  
Colour Coordination Service available on stock sizes see page 217 for full details.

**Stock White RAL 9010: 48-72 Hours**

Colours & Special / Feature Finishes: Up to 3 weeks (please allow up to 5 weeks for orders of more than 10 radiators in colours or special/ feature finishes).

Choose from our assembled stock options or build your own size by individual section, visit [theradiatorcompany.co.uk](http://theradiatorcompany.co.uk) to use our radiator builder.



**SAVE £45\***  
WHEN YOU BUY OUR IDEAL TRV & PIPE COVERS WITH ANY DESIGNER PURCHASE. QUOTE PROMOV1 AT TIME OF ORDER.

Available in White or Chrome.

**Assembled stock options RAL 9010**

**440mm High**

Height (mm)	Width (mm)	Sections	Model	Watts Δt 50°C	Btu's Δt 50°C	White		RAL Colours	RAL Colours	Special & Feature Finishes	
						Ex VAT	Inc VAT	Ex VAT	Inc VAT	Ex VAT	Inc VAT
DELIVERY TIMES						<b>48-72 HOURS</b>		UP TO 3 WEEKS		UP TO 3 WEEKS	
440	420	5	VOXS44X5	475	1621	<b>£213.80</b>	<b>£256.56</b>	£314.30	£377.16	£337.80	£405.36
	500	6	VOXS44X6	570	1945	<b>£256.56</b>	<b>£307.87</b>	£377.16	£452.59	£405.36	£486.43
	580	7	VOXS44X7	665	2269	<b>£299.32</b>	<b>£359.18</b>	£440.02	£528.02	£472.92	£567.50
	660	8	VOXS44X8	760	2593	<b>£342.08</b>	<b>£410.50</b>	£502.88	£603.46	£540.48	£648.58
	740	9	VOXS44X9	855	2917	<b>£384.84</b>	<b>£461.81</b>	£565.74	£678.89	£608.04	£729.65
	820	10	VOXS44X10	950	3241	<b>£427.60</b>	<b>£513.12</b>	£628.60	£754.32	£675.60	£810.72
	900	11	VOXS44X11	1045	3566	<b>£470.36</b>	<b>£564.43</b>	£691.46	£829.75	£743.16	£891.79
	980	12	VOXS44X12	1140	3890	<b>£513.12</b>	<b>£615.74</b>	£754.32	£905.18	£810.72	£972.86
	1060	13	VOXS44X13	1235	4214	<b>£555.88</b>	<b>£667.06</b>	£817.18	£980.62	£878.28	£1,053.94
	1140	14	VOXS44X14	1330	4538	<b>£598.64</b>	<b>£718.37</b>	£880.04	£1,056.05	£945.84	£1,135.01
	1220	15	VOXS44X15	1425	4862	<b>£641.40</b>	<b>£769.68</b>	£942.90	£1,131.48	£1,013.40	£1,216.08
	1300	16	VOXS44X16	1520	5186	<b>£684.16</b>	<b>£820.99</b>	£1,005.76	£1,206.91	£1,080.96	£1,297.15
	1380	17	VOXS44X17	1615	5510	<b>£726.92</b>	<b>£872.30</b>	£1,068.62	£1,282.34	£1,148.52	£1,378.22
	1460	18	VOXS44X18	1710	5835	<b>£769.68</b>	<b>£923.62</b>	£1,131.48	£1,357.78	£1,216.08	£1,459.30
	1540	19	VOXS44X19	1805	6159	<b>£812.44</b>	<b>£974.93</b>	£1,194.34	£1,433.21	£1,283.64	£1,540.37
	1620	20	VOXS44X20	1900	6483	<b>£855.20</b>	<b>£1,026.24</b>	£1,257.20	£1,508.64	£1,351.20	£1,621.44

Widths include measurement for bushes

Quoted prices include plugs, bushes, air vent and wall brackets.

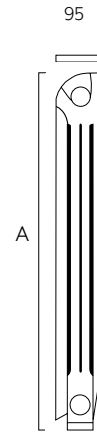

23 RAL colours are shown on page 216

**590mm High**

Height (mm)	Width (mm)	Sections	Model	Watts Δt 50°C	Btu's Δt 50°C	White		RAL Colours	RAL Colours	Special & Feature Finishes	
						Ex VAT	Inc VAT	Ex VAT	Inc VAT	Ex VAT	Inc VAT
DELIVERY TIMES						<b>48-72 HOURS</b>		UP TO 3 WEEKS		UP TO 3 WEEKS	
590	420	5	VOXS59X5	635	2167	<b>£217.60</b>	<b>£261.12</b>	£319.85	£383.82	£343.80	£412.56
	500	6	VOXS59X6	762	2600	<b>£261.12</b>	<b>£313.34</b>	£383.82	£460.58	£412.56	£495.07
	580	7	VOXS59X7	889	3033	<b>£304.64</b>	<b>£365.57</b>	£447.79	£537.35	£481.32	£577.58
	660	8	VOXS59X8	1016	3467	<b>£348.16</b>	<b>£417.79</b>	£511.76	£614.11	£550.08	£660.10
	740	9	VOXS59X9	1143	3900	<b>£391.68</b>	<b>£470.02</b>	£575.73	£690.88	£618.84	£742.61
	820	10	VOXS59X10	1270	4333	<b>£435.20</b>	<b>£522.24</b>	£639.70	£767.64	£687.60	£825.12
	900	11	VOXS59X11	1397	4767	<b>£478.72</b>	<b>£574.46</b>	£703.67	£844.40	£756.36	£907.63
	980	12	VOXS59X12	1524	5200	<b>£522.24</b>	<b>£626.69</b>	£767.64	£921.17	£825.12	£990.14
	1060	13	VOXS59X13	1651	5633	<b>£565.76</b>	<b>£678.91</b>	£831.61	£997.93	£893.88	£1,072.66
	1140	14	VOXS59X14	1778	6067	<b>£609.28</b>	<b>£731.14</b>	£895.58	£1,074.70	£962.64	£1,155.17
	1220	15	VOXS59X15	1905	6500	<b>£652.80</b>	<b>£783.36</b>	£959.55	£1,151.46	£1,031.40	£1,237.68
	1300	16	VOXS59X16	2032	6933	<b>£696.32</b>	<b>£835.58</b>	£1,023.52	£1,228.22	£1,100.16	£1,320.19
	1380	17	VOXS59X17	2159	7367	<b>£739.84</b>	<b>£887.81</b>	£1,087.49	£1,304.99	£1,168.92	£1,402.70
	1460	18	VOXS59X18	2286	7800	<b>£783.36</b>	<b>£940.03</b>	£1,151.46	£1,381.75	£1,237.68	£1,485.22
	1540	19	VOXS59X19	2413	8233	<b>£826.88</b>	<b>£992.26</b>	£1,215.43	£1,458.52	£1,306.44	£1,567.73
	1620	20	VOXS59X20	2540	8666	<b>£870.40</b>	<b>£1,044.48</b>	£1,279.40	£1,535.28	£1,375.20	£1,650.24

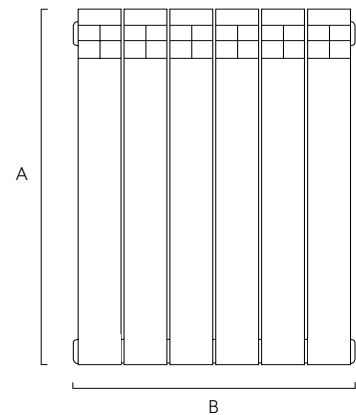

Pipe centres left to right	Pipe centres from wall	Depth from wall
width + valves	67mm to 71mm	114mm to 118mm

23 RAL colours are shown on page 216

\*Saving based on the value of individual items when bought separately. Order any of our selected valves & matching pipe covers at the same time as your radiator; PROMOV1W (white), PROMOV1C (chrome).





High quality Italian design & manufacture.  
Sectional Aluminium. CE/UKCA approved & certified to BS EN442.

White RAL 9010 as standard, 23 RAL colours plus 30 Special Finishes & 6 new Feature Finishes. Please call **01342 302250** for a RAL or Special Finish chart  
Colour Coordination Service available on stock sizes see page 217 for full details.

**Stock White RAL 9010: 48-72 Hours**

Colours & Special / Feature Finishes: Up to 3 weeks (please allow up to 5 weeks for orders of more than 10 radiators in colours or special/ feature finishes).

Choose from our assembled stock options or build your own size by individual section, visit [theradiatorcompany.co.uk](http://theradiatorcompany.co.uk) to use our radiator builder.



Ideal TRV & Pipe Covers



**SAVE £45\***  
WHEN YOU BUY OUR IDEAL TRV & PIPE COVERS WITH ANY DESIGNER PURCHASE. QUOTE **PROMOVI** AT TIME OF ORDER.

Available in White or Chrome.

**Assembled stock options RAL 9010**

**390mm High**

Height (mm)	Width (mm)	Sections	Model	Watts Δt 50°C	Btu's Δt 50°C	White Ex VAT		RAL Colours Ex VAT	RAL Colours Inc VAT	Special & Feature Finishes	
						White Ex VAT	White Inc VAT	Ex VAT	Inc VAT	Ex VAT	Inc VAT
DELIVERY TIMES						48-72 HOURS		UP TO 3 WEEKS		UP TO 3 WEEKS	
390	420	5	MIXS39X5	410	1399	£209.40	£251.28	£305.70	£366.84	£330.85	£397.02
	500	6	MIXS39X6	492	1679	£251.28	£301.54	£366.84	£440.21	£397.02	£476.42
	580	7	MIXS39X7	574	1958	£293.16	£351.79	£427.98	£513.58	£463.19	£555.83
	660	8	MIXS39X8	656	2238	£335.04	£402.05	£489.12	£586.94	£529.36	£635.23
	740	9	MIXS39X9	738	2518	£376.92	£452.30	£550.26	£660.31	£595.53	£714.64
	820	10	MIXS39X10	820	2798	£418.80	£502.56	£611.40	£733.68	£661.70	£794.04
	900	11	MIXS39X11	902	3078	£460.68	£552.82	£672.54	£807.05	£727.87	£873.44
	980	12	MIXS39X12	984	3357	£502.56	£603.07	£733.68	£880.42	£794.04	£952.85
	1060	13	MIXS39X13	1066	3637	£544.44	£653.33	£794.82	£953.78	£860.21	£1,032.25
	1140	14	MIXS39X14	1148	3917	£586.32	£703.58	£855.96	£1,027.15	£926.38	£1,111.66
	1220	15	MIXS39X15	1230	4197	£628.20	£753.84	£917.10	£1,100.52	£992.55	£1,191.06
	1300	16	MIXS39X16	1312	4477	£670.08	£804.10	£978.24	£1,173.89	£1,058.72	£1,270.46
	1380	17	MIXS39X17	1394	4756	£711.96	£854.35	£1,039.38	£1,247.26	£1,124.89	£1,349.87
	1460	18	MIXS39X18	1476	5036	£753.84	£904.61	£1,100.52	£1,320.62	£1,191.06	£1,429.27
1540	19	MIXS39X19	1558	5316	£795.72	£954.86	£1,161.66	£1,393.99	£1,257.23	£1,508.68	
1620	20	MIXS39X20	1640	5596	£837.60	£1,005.12	£1,222.80	£1,467.36	£1,323.40	£1,588.08	

23 RAL colours are shown on page 216

**440mm High**

Height (mm)	Width (mm)	Sections	Model	Watts Δt 50°C	Btu's Δt 50°C	White Ex VAT		RAL Colours Ex VAT	RAL Colours Inc VAT	Special & Feature Finishes	
						White Ex VAT	White Inc VAT	Ex VAT	Inc VAT	Ex VAT	Inc VAT
DELIVERY TIMES						48-72 HOURS		UP TO 3 WEEKS		UP TO 3 WEEKS	
440	420	5	MIXS44X5	470	1604	£213.80	£256.56	£312.15	£374.58	£337.80	£405.36
	500	6	MIXS44X6	564	1924	£256.56	£307.87	£374.58	£449.50	£405.36	£486.43
	580	7	MIXS44X7	658	2245	£299.32	£359.18	£437.01	£524.41	£472.92	£567.50
	660	8	MIXS44X8	752	2566	£342.08	£410.50	£499.44	£599.33	£540.48	£648.58
	740	9	MIXS44X9	846	2887	£384.84	£461.81	£561.87	£674.24	£608.04	£729.65
	820	10	MIXS44X10	940	3207	£427.60	£513.12	£624.30	£749.16	£675.60	£810.72
	900	11	MIXS44X11	1034	3528	£470.36	£564.43	£686.73	£824.08	£743.16	£891.79
	980	12	MIXS44X12	1128	3849	£513.12	£615.74	£749.16	£898.99	£810.72	£972.86
	1060	13	MIXS44X13	1222	4169	£555.88	£667.06	£811.59	£973.91	£878.28	£1,053.94
	1140	14	MIXS44X14	1316	4490	£598.64	£718.37	£874.02	£1,048.82	£945.84	£1,135.01
	1220	15	MIXS44X15	1410	4811	£641.40	£769.68	£936.45	£1,123.74	£1,013.40	£1,216.08
	1300	16	MIXS44X16	1504	5132	£684.16	£820.99	£998.88	£1,198.66	£1,080.96	£1,297.15
	1380	17	MIXS44X17	1598	5452	£726.92	£872.30	£1,061.31	£1,273.57	£1,148.52	£1,378.22
	1460	18	MIXS44X18	1692	5773	£769.68	£923.62	£1,123.74	£1,348.49	£1,216.08	£1,459.30
1540	19	MIXS44X19	1786	6094	£812.44	£974.93	£1,186.17	£1,423.40	£1,283.64	£1,540.37	
1620	20	MIXS44X20	1880	6415	£855.20	£1,026.24	£1,248.60	£1,498.32	£1,351.20	£1,621.44	

23 RAL colours are shown on page 216

Widths include measurement for bushes

Quoted prices include plugs, bushes, air vent and wall brackets.

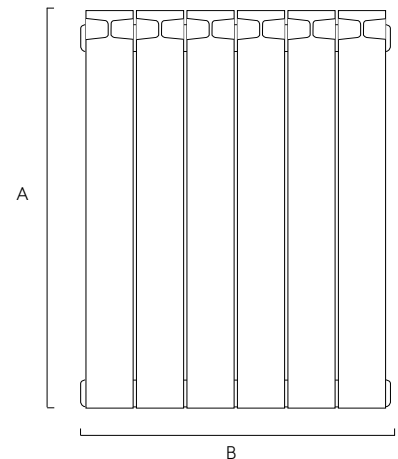
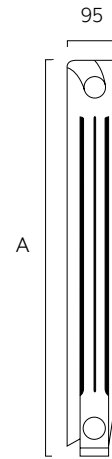

Pipe centres left to right	Pipe centres from wall	Depth from wall
width + valves	67mm to 71mm	114mm to 118mm

\*Saving based on the value of individual items when bought separately. Order any of our selected valves & matching pipe covers at the same time as your radiator; PROMOVIW (white), PROMOVIW (chrome).



# Cast Iron



Our cast iron range includes a choice of ornate and plain schoolhouse designs. Available in a choice of finishes, including painted, polished and burnished, cast iron radiators can be specified by section so you can choose the right size for your space.



**SAVE £45\***  
WHEN YOU BUY OUR **VINTAGE TRV KIT** WITH ANY CAST IRON PURCHASE. PLEASE QUOTE **PROMOV2** AT TIME OF ORDER.

\*Saving based on the value of individual items when bought separately. Order any of our selected valves and matching pipe covers at the same time as your radiator.

## Choose your radiator using our **NEW** online radiator builder

Once you know your outputs use our **online radiator builder** to select the best solution for your room. It will take you through the process quickly and easily and allows you to save your ideas to your own Wish List.

Go to our website [theradiatorcompany.co.uk](http://theradiatorcompany.co.uk)

It is vital to know the correct heat output you need to keep your room warm, use our online Heat Output Calculator to get a guide to your requirements which you can then check with your installer.

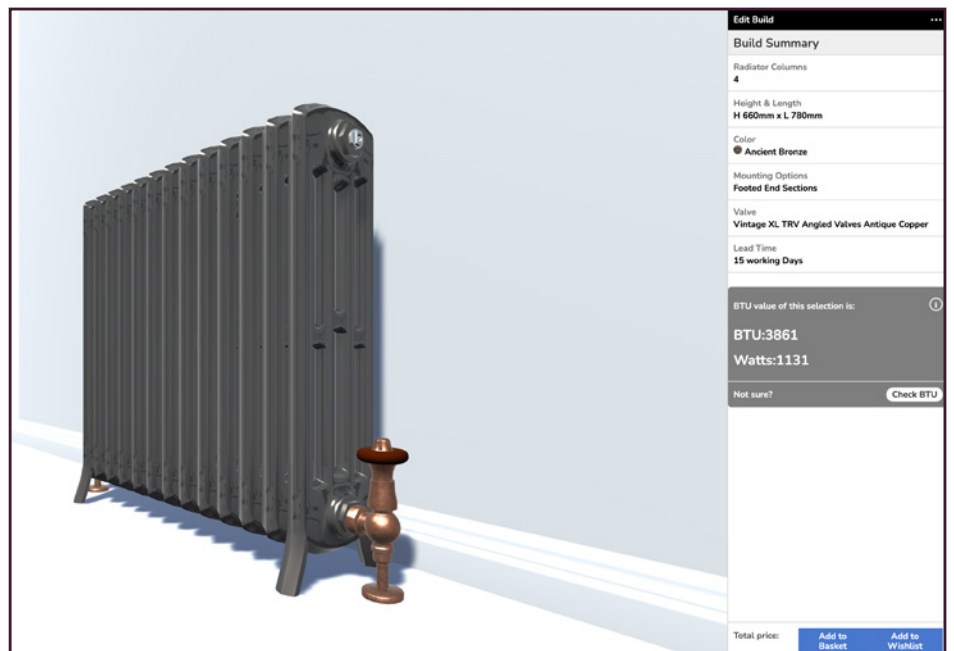

Once you know your outputs you can also use the brochure to specify your radiator by following these steps (or call our Customer Services team on 01342 302250 who will help you size your radiator)

- Note the space you have in mind for the radiator(s) you need; vertical or horizontal, length, height & depth
- Select a column option and height that fits your space; Calculate the number of sections you need by dividing the required BTU (Watt) output with the output per section; e.g 1913 BTUs divided by 328 = 6 sections, based on 4 column, 580mm high sections (always round up to the next whole number of sections)
- If using that section size doesn't work in the space available, try a different column option or if possible a different height
- Once you have calculated the best number and size of section, select the best mounting option and kit; footed end section, cast feet or wall brackets. For the Telford and Ledbury you have the option of footed ends (selected sizes on Telford), cast feet or wall brackets. Aston, Trieste, Bohemia and Linton ranges are only available with footed ends.
- Your cast iron radiator can be painted in a selection of the most popular colours from the RAL range, special finishes, feature finishes or in a polished or burnished finish (Aston, Bohemia or Linton only). Please specify your chosen colour at time of order. Please note: as a result of the casting process, cast iron radiators have a rough surface finish with small imperfections which will show after the painting process.
- Work out the price of your radiator; e.g Telford 4 column, 580 high, 6 section, RAL 7044 Silk Grey = £125.57 x 6 = £753.42 + cast feet kit (2) £95.26 = £848.68 Inc VAT
- Place your order with your local Merchant using the sectional model code x No. of sections needed, noting the mounting option and the name and number of colour you have chosen; e.g TELF4C58 x 6 sections, RAL 7044 Silk Grey with cast feet
- If you have chosen a colour make sure you list the colour number and name

All prices and outputs are given per section in the tables on pages 185-194. Price per section includes plugs, bushes and diverter. Mounting options must be selected separately, these will include the air vent and appropriate number of wall ties.



# Aston shown on pages 78-79



Cast Iron; 2, 3, 4 & 6 column, footed ends as standard  
CE/UKCA approved & certified to BS EN442.

24 RAL colours (shown on page 197) and a Polished finish.  
Please call **01342 302250** for a RAL chart

24 RAL colours: up to 6 weeks  
Polished: up to 6 weeks  
Please add 10 working days for orders of more than 10 radiators



Vintage TRV & Pipe Covers



**SAVE £45\***  
WHEN YOU BUY OUR VINTAGE TRV & PIPE COVERS WITH ANY CAST IRON PURCHASE.  
QUOTE PROMOV2 AT TIME OF ORDER.

For all Vintage TRV finishes

## Aston Sectional options with footed end sections as standard

Build your radiator to fit your requirements using individual sections shown below, visit page 184 to help you size your radiator.  
Please note section prices are based on 8 sections or more, for anything less than 8 sections prices will be on application.  
If you require more than 40 sections please contact our Customer Services team on **01342 302250**.

### 2 Column

Height A (mm)	Width B (mm)	Model	Watts Δt 50°C	Btu's Δt 50°C	RAL Colours Ex VAT	RAL Colours Inc VAT	Polished Ex VAT	Polished Inc VAT
DELIVERY TIMES					UP TO 6 WEEKS		UP TO 6 WEEKS	
460	58.5	ASTO2C46	35	119	£59.53	£71.44	£113.11	£135.73
760	58.5	ASTO2C76	59	201	£69.62	£83.54	£132.28	£158.74
960	58.5	ASTO2C96	74	252	£78.29	£93.95	£148.75	£178.50

### 3 Column

Height A (mm)	Width B (mm)	Model	Watts Δt 50°C	Btu's Δt 50°C	RAL Colours Ex VAT	RAL Colours Inc VAT	Polished Ex VAT	Polished Inc VAT
DELIVERY TIMES					UP TO 6 WEEKS		UP TO 6 WEEKS	
560	58.5	ASTO3C56	54	184	£72.94	£87.53	£138.59	£166.31
660	58.5	ASTO3C66	66	225	£81.13	£97.36	£154.15	£184.98
760	58.5	ASTO3C76	78	266	£83.48	£100.18	£158.61	£190.33
860	58.5	ASTO3C86	87	297	£95.17	£114.20	£180.82	£216.98

### 4 Column

Height A (mm)	Width B (mm)	Model	Watts Δt 50°C	Btu's Δt 50°C	RAL Colours Ex VAT	RAL Colours Inc VAT	Polished Ex VAT	Polished Inc VAT
DELIVERY TIMES					UP TO 6 WEEKS		UP TO 6 WEEKS	
360	58.5	ASTO4C36	45	154	£65.42	£78.50	£124.30	£149.16
460	58.5	ASTO4C46	58	198	£73.73	£88.48	£140.09	£168.11
560	58.5	ASTO4C56	69	235	£85.09	£102.11	£161.67	£194.00
760	58.5	ASTO4C76	96	328	£105.59	£126.71	£200.62	£240.74
860	58.5	ASTO4C86	109	372	£112.67	£135.20	£214.07	£256.88
960	58.5	ASTO4C96	121	413	£128.39	£154.07	£243.94	£292.73

### 6 Column

Height A (mm)	Width B (mm)	Model	Watts Δt 50°C	Btu's Δt 50°C	RAL Colours Ex VAT	RAL Colours Inc VAT	Polished Ex VAT	Polished Inc VAT
DELIVERY TIMES					UP TO 6 WEEKS		UP TO 6 WEEKS	
960	58.5	ASTO6C96	168	573	£159.23	£191.08	£302.54	£363.05

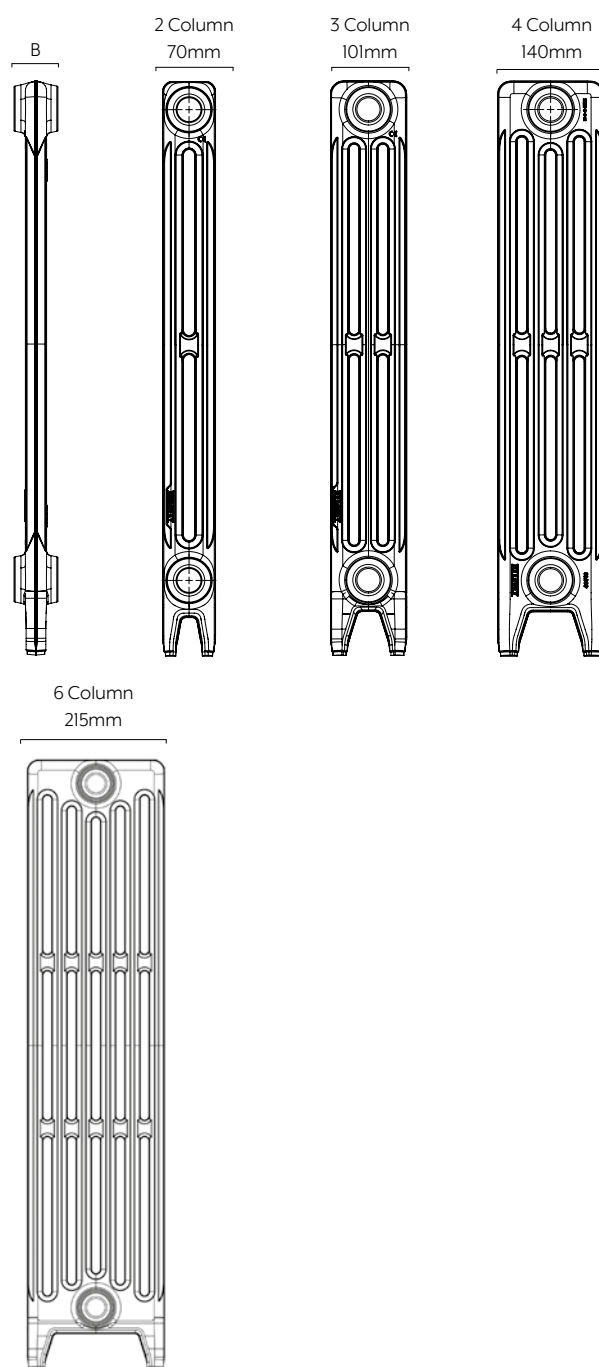

Aston	Pipe centres left to right	Pipe centres from wall
2 Column	58.5 x number of sections + 25mm bushes + valves	68mm to 83mm
3 Column	58.5 x number of sections + 25mm bushes + valves	84mm to 99mm
4 Column	58.5 x number of sections + 25mm bushes + valves	103mm to 118mm
6 Column	58.5 x number of sections + 25mm bushes + valves	140mm to 155mm

\*Saving based on the value of individual items when bought separately. Order any of our selected valves and matching pipe covers at the same time as your radiator.

# Ledbury shown on pages 74-75



Cast Iron; 4 or 6 column footed ends as standard, optional cast feet or wall brackets available. CE/UKCA approved & certified to BS EN442.



Supplied in a standard primer, ready to be painted in your desired finish. 24 RAL colours (shown on page 216) 29 special finishes & 6 new feature finishes. Please call **01342 302250** for a RAL or Special Finish chart. Colour Coordination Service available, see page 217 for full details.

**Stock Primer: 5-7 working days.** RAL colours & special / feature finishes: up to 3 weeks, Please add 10 working days for orders of more than 10 radiators.



**SAVE £45\***  
WHEN YOU BUY OUR VINTAGE TRV & PIPE COVERS WITH ANY CAST IRON PURCHASE. QUOTE **PROMOV2** AT TIME OF ORDER.

For all Vintagee TRV finishes

## Ledbury Sectional options

Available with footed end sections as standard, wall brackets and cast feet are also available. Please see alternative mounting options on page 187 or call customer services on **01342 302250** for more information and prices.

Build your radiator to fit your requirements using individual sections shown below, visit page 184 to help you size your radiator. If you require more than 40 sections please contact our Customer Services team on **01342 302250**.

### 4 Column

Height A (mm)	Width B (mm)	Model	Watts Δt 50°C	Btu's Δt 50°C	Primer Ex VAT	Primer Inc VAT	RAL Colours Ex VAT	RAL Colours Inc VAT	Special & Feature Finishes Ex VAT	Special & Feature Finishes Inc VAT
DELIVERY TIMES					5-7 WORKING DAYS		UP TO 3 WEEKS		UP TO 3 WEEKS	
660	60	NLEDB4C65	87	297	£55.70	£66.84	£89.12	£106.94	£105.83	£127.00
760	60	NLEDB4C76	101	345	£70.86	£85.03	£113.38	£136.06	£134.63	£161.56
960	60	NLEDB4C95	125	427	£83.51	£100.21	£133.62	£160.34	£158.67	£190.40

4 column



### 6 Column

Height A (mm)	Width B (mm)	Model	Watts Δt 50°C	Btu's Δt 50°C	Primer Ex VAT	Primer Inc VAT	RAL Colours Ex VAT	RAL Colours Inc VAT	Special & Feature Finishes Ex VAT	Special & Feature Finishes Inc VAT
DELIVERY TIMES					5-7 WORKING DAYS		UP TO 3 WEEKS		UP TO 3 WEEKS	
665	60	NLEDB6C65	127	433	£81.00	£97.20	£129.60	£155.52	£153.90	£184.68
760	60	NLEDB6C76	147	502	£105.62	£126.74	£168.99	£202.79	£200.68	£240.82

6 column

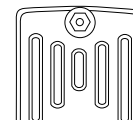

### 4 Column Mini Ledbury

Height A (mm)	Width B (mm)	Model	Watts Δt 50°C	Btu's Δt 50°C	Primer Ex VAT	Primer Inc VAT	RAL Colours Ex VAT	RAL Colours Inc VAT	Special & Feature Finishes Ex VAT	Special & Feature Finishes Inc VAT
DELIVERY TIMES					5-7 WORKING DAYS		UP TO 3 WEEKS		UP TO 3 WEEKS	
355	60	NMINLEDB4C35	46	157	£39.60	£47.52	£63.36	£76.03	£75.24	£90.29
475	60	NMINLEDB4C47	62	212	£49.88	£59.86	£79.81	£95.77	£94.77	£113.72

4 column



### 6 Column Mini Ledbury

Height A (mm)	Width B (mm)	Model	Watts Δt 50°C	Btu's Δt 50°C	Primer Ex VAT	Primer Inc VAT	RAL Colours Ex VAT	RAL Colours Inc VAT	Special & Feature Finishes Ex VAT	Special & Feature Finishes Inc VAT
DELIVERY TIMES					5-7 WORKING DAYS		UP TO 3 WEEKS		UP TO 3 WEEKS	
485	60	NMINLEDB6C48	94	321	£63.26	£75.91	£101.22	£121.46	£120.19	£144.23

6 column

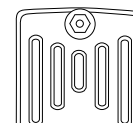

Ledbury	Pipe centres left to right	Pipe centres from wall	Footed end section depth	Section depth
4 Column	60 x number of sections + 28mm bushes + valves	105mm to 120mm	174mm (footed ends protrude 31mm total from section width)	143mm
Mini 4 Column	60 x number of sections + 28mm bushes + valves	105mm to 120mm	174mm (footed ends protrude 30mm total from section width)	144mm
6 Column	60 x number of sections + 28mm bushes + valves	130mm to 150mm	250mm (footed ends protrude 28mm total from section width)	222mm
Mini 6 Column	60 x number of sections + 28mm bushes + valves	130mm to 150mm	255mm (footed ends protrude 33mm total from section width)	222mm

4 Column

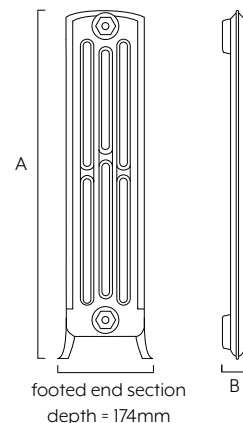

Please note for sections without footed ends deduct 60mm from the height of the section

\*Saving based on the value of individual items when bought separately. Order any of our selected valves & matching pipe covers at the same time as your radiator.

# Optional cast iron cast feet for Ledbury

If you require optional cast feet please specify at time of order by adding the relevant kit and price below. Wall Brackets are also available on request, please call 01342 302250 to discuss with our customer service team.

Up to 20 Sections	21 - 39 Sections (odd number of sections)	22 - 40 Sections (even number of sections)
2 Feet - 1 at each end	3 Feet - 1 at each end and 1 positioned centrally	4 Feet - 1 at each end and 2 spaced equally inbetween
2 Wall Ties	3 Wall Ties	4 Wall Ties

Wall Ties are included in the price and supplied as standard for all orders. Please specify your chosen mounting option at time of order.

Model	Number of Feet	Primer Ex VAT	Primer Inc VAT	RAL Colours Ex VAT	RAL Colours Inc VAT	Special & Feature Finishes Ex VAT	Special & Feature Finishes Inc VAT
DELIVERY TIMES		5-7 WORKING DAYS		UP TO 3 WEEKS		UP TO 3 WEEKS	
PPLEDBCFKIT2	2	£49.00	£58.80	£79.38	£95.26	£107.80	£129.36
PPLEDBCFKIT3	3	£77.00	£92.40	£124.74	£149.69	£169.40	£203.28
PPLEDBCFKIT4	4	£103.00	£123.60	£166.86	£200.23	£226.60	£271.92

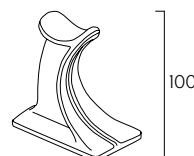

Please specify finish at time of order

If you require additional cast feet or wall ties please see pricing table below and specify at time of order

Description	Model	Primer Ex VAT	Primer Inc VAT	RAL Colours Ex VAT	RAL Colours Inc VAT	Special & Feature Finishes Ex VAT	Special & Feature Finishes Inc VAT
DELIVERY TIMES		5-7 WORKING DAYS		UP TO 3 WEEKS		UP TO 3 WEEKS	
Cast foot (each)	PPCIFM01	£22.00	£26.40	£38.06	£45.67	£49.94	£59.93
Wall tie (each)	PPCIWT01	£5.00	£6.00	N/A	N/A	N/A	N/A

Please remember to add 100mm to the height of the Ledbury section you have chosen if you are using cast feet.

## Solid Brass Cast Iron Wall Ties & Airvents New

These solid brass wall ties provide a stylish finishing touch to any cast iron radiator; select to match your valves. Available as a kit including matching airvent in Antique Brass, Chrome, Polished Brass and Brushed Nickel. Please note that these wall ties and airvents are an optional extra and do not come as standard with your cast iron radiator.

Please specify finish at time of order

Description	Model	Number of Wall Ties	Number of Airvents	Price Ex VAT	Price Inc VAT
DELIVERY TIMES		48-72 HOURS			
Single Wall Tie	PPCIWT	1	N/A	£68.00	£81.60
Single Airvent	PPLAV	N/A	1	£12.00	£14.40
Wall Tie & Airvent Kit	PPCIWTAVKIT2	2	1	£143.00	£171.60
Wall Tie & Airvent Kit	PPCIWTAVKIT3	3	1	£205.00	£246.00
Wall Tie & Airvent Kit	PPCIWTAVKIT4	4	1	£270.00	£324.00
Wall Tie & Airvent Kit	PPCIWTAVKIT5	5	1	£334.00	£400.80

Antique Brass

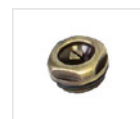

Chrome



Polished Brass

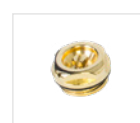

Brushed Nickel



## Feature Finishes

Please call **01342 302250** for sample swatches.

New

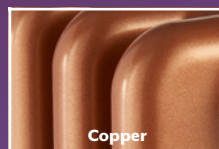
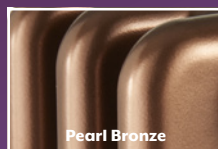
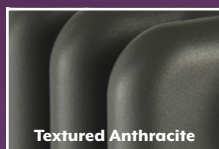
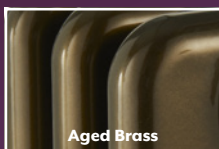



Cast Iron; Mounting options include cast feet, footed ends (selected sizes) or wall brackets. CE/UKCA approved & certified to BS EN442.



Supplied in a standard primer, ready to be painted in your desired finish  
24 RAL colours (shown on page 216), 29 special finishes & 6 new feature finishes.

Please call **01342 302250** for a RAL or Special Finish chart

Colour Coordination Service available, see page 217 for full details.

**Stock Primer: 5-7 working days.** RAL colours & special / feature finishes: up to 5 weeks. Please add 10 working days for orders of more than 10 radiators.



**SAVE £45\***  
WHEN YOU BUY OUR VINTAGE TRV & PIPE COVERS WITH ANY CAST IRON PURCHASE. QUOTE **PROMOV2** AT TIME OF ORDER.

For all Vintage TRV finishes

## Telford Sectional options with footed end sections

Build your radiator to fit your requirements using individual sections shown below, visit page 184 to help you size your radiator. If you require more than 40 sections please contact our Customer Services team on 01342 302250.

### 2 Column

Height A (mm)	Width B (mm)	Model	Watts Δt 50°C	Btu's Δt 50°C	Primer Ex VAT	Primer Inc VAT	RAL Colours Ex VAT	RAL Colours Inc VAT	Special & Feature Finishes Ex VAT	Special & Feature Finishes Inc VAT
DELIVERY TIMES					<b>5-7 WORKING DAYS</b>		UP TO 5 WEEKS		UP TO 5 WEEKS	
485	60	TELF2C43FS	43	147	<b>£29.57</b>	<b>£35.48</b>	£48.79	£58.55	£60.62	£72.74
735	60	TELF2C68FS	63	215	<b>£41.64</b>	<b>£49.97</b>	£68.71	£82.45	£85.36	£102.43
1035	60	TELF2C98FS	86	293	<b>£53.71</b>	<b>£64.45</b>	£88.62	£106.34	£110.11	£132.13

Please specify your finish at time of order, lead times vary for different finishes so please see information on delivery.

Telford	Pipe centres left to right	Pipe centres from wall
2 Column	60 x number of sections + 30mm bushes + valves	85mm to 105mm
4 Column	60 x number of sections + 30mm bushes + valves	130mm to 150mm
6 Column	60 x number of sections + 30mm bushes + valves	175mm to 195mm

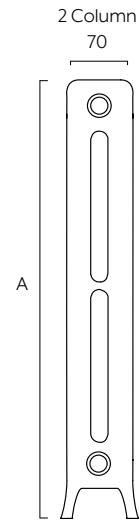

**Telford Sectional options** please see opposite for floor mounting options, wall brackets are available on request, please call customer services on 01342 302250 for more information and prices

Build your radiator to fit your requirements using individual sections shown below, visit page 184 to help you size your radiator. If you require more than 40 sections please contact our Customer Services team on 01342 302250.

### 2 Column

Height A (mm)	Width B (mm)	Model	Watts Δt 50°C	Btu's Δt 50°C	Primer Ex VAT	Primer Inc VAT	RAL Colours Ex VAT	RAL Colours Inc VAT	Special & Feature Finishes Ex VAT	Special & Feature Finishes Inc VAT
DELIVERY TIMES					<b>5-7 WORKING DAYS</b>		UP TO 5 WEEKS		UP TO 5 WEEKS	
430	60	TELF2C43	43	147	<b>£29.57</b>	<b>£35.48</b>	£48.79	£58.55	£60.62	£72.74
680	60	TELF2C68	63	215	<b>£41.64</b>	<b>£49.97</b>	£68.71	£82.45	£85.36	£102.43
980	60	TELF2C98	86	293	<b>£53.71</b>	<b>£64.45</b>	£88.62	£106.34	£110.11	£132.13

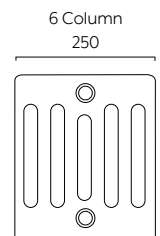
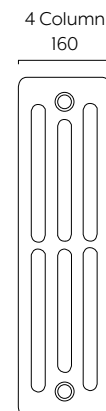
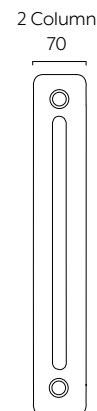

### 4 Column

Height A (mm)	Width B (mm)	Model	Watts Δt 50°C	Btu's Δt 50°C	Primer Ex VAT	Primer Inc VAT	RAL Colours Ex VAT	RAL Colours Inc VAT	Special & Feature Finishes Ex VAT	Special & Feature Finishes Inc VAT
DELIVERY TIMES					<b>5-7 WORKING DAYS</b>		UP TO 5 WEEKS		UP TO 5 WEEKS	
580	60	TELF4C58	96	328	<b>£63.42</b>	<b>£76.10</b>	£104.64	£125.57	£130.01	£156.01

### 6 Column

Height A (mm)	Width B (mm)	Model	Watts Δt 50°C	Btu's Δt 50°C	Primer Ex VAT	Primer Inc VAT	RAL Colours Ex VAT	RAL Colours Inc VAT	Special & Feature Finishes Ex VAT	Special & Feature Finishes Inc VAT
DELIVERY TIMES					<b>5-7 WORKING DAYS</b>		UP TO 5 WEEKS		UP TO 5 WEEKS	
280	60	TELF6C28	72	246	<b>£51.76</b>	<b>£62.11</b>	£85.40	£102.48	£106.11	£127.33

\*Saving based on the value of individual items when bought separately. Order any of our selected valves & matching pipe covers at the same time as your radiator.

# Optional Cast iron cast feet for Telford

If you require optional Cast Feet please specify at time of order by adding the relevant kit and price below. Wall Brackets are also available on request, please call 01342 302250 to discuss with our customer service team.

Up to 20 Sections	21 - 39 Sections (odd number of sections)	22 - 40 Sections (even number of sections)
2 Feet - 1 at each end	3 Feet - 1 at each end and 1 positioned centrally	4 Feet - 1 at each end and 2 spaced equally inbetween
2 Wall Ties	3 Wall Ties	4 Wall Ties

Wall Ties are included in the price and supplied as standard for all orders. Please specify your chosen mounting option at time of order.

Model	Number of Feet	Primer Ex VAT	Primer Inc VAT	RAL Colours Ex VAT	RAL Colours Inc VAT	Special & Feature Finishes Ex VAT	Special & Feature Finishes Inc VAT
DELIVERY TIMES		5-7 WORKING DAYS		UP TO 5 WEEKS		UP TO 5 WEEKS	
PPTLFCFKIT2	2	£49.00	£58.80	£79.38	£95.26	£107.80	£129.36
PPTLFCFKIT3	3	£77.00	£92.40	£124.74	£149.69	£169.40	£203.28
PPTLFCFKIT4	4	£103.00	£123.60	£166.86	£200.23	£226.60	£271.92

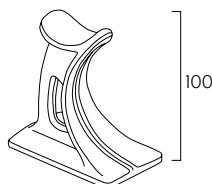

Please specify finish at time of order

If you require additional cast feet or wall ties please see pricing table below and specify at time of order

Description	Model	Primer Ex VAT	Primer Inc VAT	RAL Colours Ex VAT	RAL Colours Inc VAT	Special & Feature Finishes Ex VAT	Special & Feature Finishes Inc VAT
DELIVERY TIMES		5-7 WORKING DAYS		UP TO 5 WEEKS		UP TO 5 WEEKS	
Cast foot (each)	PPANSFM01	£22.00	£26.40	£38.06	£45.67	£49.94	£59.93
Wall tie (each)	PPCIWT01	£5.00	£6.00	N/A	N/A	N/A	N/A

Please remember to add 100mm to the height of the Telford section you have chosen if you are using Cast Feet.

**Feature Finishes** New

Please call customer services for sample swatches.



Copper

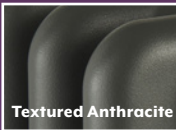

Textured Anthracite



Vintage Green

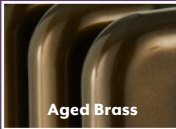

Aged Brass

## Solid Brass Cast Iron Wall Ties & Airvents

These solid brass wall ties provide a stylish finishing touch to any cast iron radiator; select to match your valves. Available as a kit including matching airvent in Antique Brass, Chrome, Polished Brass and Brushed Nickel. Please note that these wall ties and airvents are an optional extra and do not come as standard with your cast iron radiator.

Description	Model	Number of Wall Ties	Number of Airvents	Price Ex VAT	Price Inc VAT
DELIVERY TIMES				48-72 HOURS	
Single Wall Tie	PPCIWT	1	N/A	£68.00	£81.60
Single Airvent	PPLAV	N/A	1	£12.00	£14.40
Wall Tie & Airvent Kit	PPCIWTAVKIT2	2	1	£143.00	£171.60
Wall Tie & Airvent Kit	PPCIWTAVKIT3	3	1	£205.00	£246.00
Wall Tie & Airvent Kit	PPCIWTAVKIT4	4	1	£270.00	£324.00
Wall Tie & Airvent Kit	PPCIWTAVKIT5	5	1	£334.00	£400.80

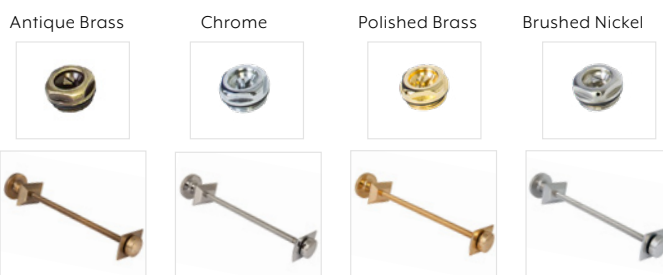

Please specify finish at time of order

## Joining Keys

Cast iron radiators come assembled up to a maximum of 10 sections. Radiators larger than these will require on-site assembly using a Joining Key.

- The Heavy Duty Joining Key is available on a sale or return basis.** Joining Keys must be specified at time of order for assistance please contact our Customer Service team on 01342 302250, they will also arrange a courier to collect it from you when you are ready.

Description	Model	Price Ex VAT	Price Inc VAT
DELIVERY TIMES			
48-72 HOURS			
Heavy duty joining tool	PPASMT5	£557.00	£668.40

Heavy Duty Joining Tool (includes tommy bar) engineered in the UK



# Linton shown on pages 82-83

Cast Iron; 2 or 3 column footed ends only  
CE/UKCA approved & certified to BS EN442.

24 RAL colours (shown on page 216), 4 special finishes, Polished & Burnished finishes plus 1 Galvanised finish (details below).  
Please call **01342 302250** for a RAL chart.

Made to order: RAL colours, Soft Gold, Slate Grey, Flat Black up to 5 weeks.  
Antique Brass, Burnished, Galvanised Copper & Polished up to 7 weeks.  
Please add 10 working days for orders of more than 10 radiators.



**Vintage TRV & Pipe Covers**



**SAVE £45\***  
WHEN YOU BUY OUR VINTAGE TRV & PIPE COVERS WITH ANY CAST IRON PURCHASE. QUOTE **PROMOV2** AT TIME OF ORDER.

For all Vintage TRV finishes

## Linton Sectional options

Free standing with footed ends only

### RAL & Special Finishes (Soft Gold, Slate Grey, Flat Black)

2 Column

Height A (mm)	Width B (mm)	Model	Watts Δt 50°C	Btu's Δt 50°C	RAL Colours Ex VAT	RAL Colours Inc VAT	Special Finishes Ex VAT	Special Finishes Inc VAT
DELIVERY TIMES			UP TO 5 WEEKS		UP TO 5 WEEKS			
521	82	LINT2C521	86	293	£136.15	£163.38	£146.15	£175.38
621	82	LINT2C621	103	351	£154.90	£185.88	£168.63	£202.36
721	82	LINT2C721	124	423	£159.88	£191.86	£177.38	£212.86
921	82	LINT2C921	161	549	£191.12	£229.34	£201.11	£241.33

3 Column

Height A (mm)	Width B (mm)	Model	Watts Δt 50°C	Btu's Δt 50°C	RAL Colours Ex VAT	RAL Colours Inc VAT	Special Finishes Ex VAT	Special Finishes Inc VAT
DELIVERY TIMES			UP TO 5 WEEKS		UP TO 5 WEEKS			
621	82	LINT3C621	119	406	£184.87	£221.84	£191.12	£229.34
721	82	LINT3C721	138	471	£192.37	£230.84	£224.85	£269.82
921	82	LINT3C921	176	601	£232.34	£278.81	£262.32	£314.78



Soft Gold

Slate Grey

Flat Black

Please specify your finish at time of order, delivery time is 5 weeks

### Burnished & Polished Finishes

2 Column

Height A (mm)	Width B (mm)	Model	Watts Δt 50°C	Btu's Δt 50°C	Burnished Ex VAT	Burnished Inc VAT	Polished Ex VAT	Polished Inc VAT
DELIVERY TIMES			UP TO 7 WEEKS		UP TO 7 WEEKS			
521	82	LINT2C521	86	293	£153.64	£184.37	£158.64	£190.37
621	82	LINT2C621	103	351	£178.63	£214.36	£186.11	£223.33
721	82	LINT2C721	124	423	£187.37	£224.84	£209.85	£251.82
921	82	LINT2C921	161	549	£223.60	£268.32	£266.07	£319.28

3 Column

Height A (mm)	Width B (mm)	Model	Watts Δt 50°C	Btu's Δt 50°C	Burnished Ex VAT	Burnished Inc VAT	Polished Ex VAT	Polished Inc VAT
DELIVERY TIMES			UP TO 7 WEEKS		UP TO 7 WEEKS			
621	82	LINT3C621	119	406	£203.61	£244.33	£247.33	£296.80
721	82	LINT3C721	138	471	£241.08	£289.30	£293.55	£352.26
921	82	LINT3C921	176	601	£279.81	£335.77	£337.27	£404.72



Burnished

Polished

Please specify your finish at time of order, delivery time is 7 weeks for Burnished and 7 weeks for Polished.

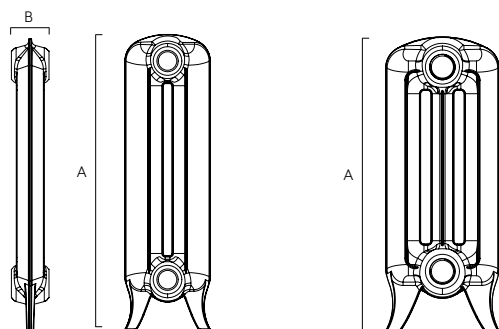

Linton	Pipe centres left to right	Pipe centres from wall	Depth from wall
2 Column	82 x number of sections + 32mm + valves	120mm	210mm
3 Column	82 x number of sections + 32mm + valves	130mm	230mm

\*Saving based on the value of individual items when bought separately. Order any of our selected valves & matching pipe covers at the same time as your radiator.

## Antique Brass & Galvanised Finish Antique Copper

If selecting Antique Brass please read the below about the finish.

2 Column

Height A (mm)	Width B (mm)	Model	Watts $\Delta t$ 50°C	Btu's $\Delta t$ 50°C	Antique Brass Ex VAT	Antique Brass Inc VAT	Galvanic Copper Ex VAT	Galvanic Copper Inc VAT
DELIVERY TIMES					UP TO 7 WEEKS		UP TO 7 WEEKS	
521	82	LINT2C521	86	293	£211.10	£253.32	£227.34	£272.81
621	82	LINT2C621	103	351	£226.10	£271.32	£251.08	£301.30
721	82	LINT2C721	124	423	£242.33	£290.80	£268.56	£322.27
921	82	LINT2C921	161	549	£282.30	£338.76	£332.27	£398.72

3 Column

Height A (mm)	Width B (mm)	Model	Watts $\Delta t$ 50°C	Btu's $\Delta t$ 50°C	Antique Brass Ex VAT	Antique Brass Inc VAT	Galvanic Copper Ex VAT	Galvanic Copper Inc VAT
DELIVERY TIMES					UP TO 7 WEEKS		UP TO 7 WEEKS	
621	82	LINT3C621	119	406	£254.82	£305.78	£281.05	£337.26
721	82	LINT3C721	138	471	£294.79	£353.75	£332.27	£398.72
921	82	LINT3C921	176	601	£347.27	£416.72	£408.47	£490.16

Please specify your finish at time of order, delivery time is 7 weeks for Antique Brass and Galvanised Antique Copper.



Galvanised Copper

Antique Brass

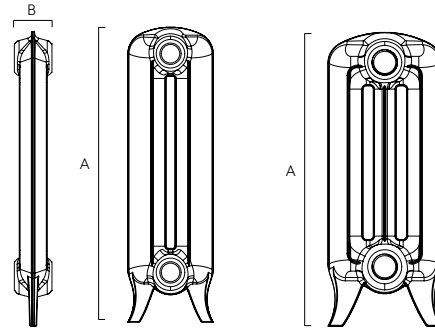

Linton	Pipe centres left to right	Pipe centres from wall	Depth from wall
2 Column	82 x number of sections + 32mm + valves	120mm	210mm
3 Column	82 x number of sections + 32mm + valves	130mm	230mm

## Antique Brass Finish

Cast iron is a classic favourite, loved for its traditional qualities and style. Part of the charm of cast iron is the inherent imperfections and idiosyncrasies in the metal produced by the traditional production methods. Newly cast product retains the texture and individuality of radiators cast over 100 years ago, but in order to create an aged appearance to the finish, they go through a number of stages ending with a hand-finished application. The appeal of an antique product is its unique patina developed over time, each radiator will differ, and so to reproduce that effect our Antique finishes will have a varying depth of light and dark across the radiator.

After cleaning, priming and the application of the brass effect powder coat each radiator has an antique rub applied by hand. This is then rubbed down and baked to fix the protective surface. The level and amount of light and dark differ from section to section as the combination of texture, casting marks and the random nature of hand finishing produces a striking and unique antiqued finish.

Casting marks and textures retain the antique topcoat, highlighting the natural surface texture of the cast metal

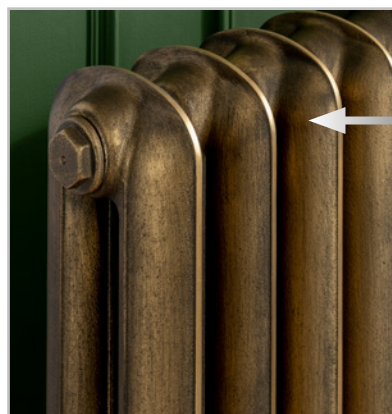

Darker areas occur when hard to access areas and mould patterns retain more of the antique rub, creating an individual final finish.

# Stamford shown on pages 78-79

Cast Iron; 2 column footed ends only  
CE/UKCA approved & certified to BS EN442

24 RAL colours (shown on page 216), 4 special finishes, Burnished finishes plus 1 Galvanised finish (details below). Please call **01342 302250** for a RAL chart.

Made to order: RAL colours, Soft Gold, Slate Grey, Flat Black up to 5 weeks.  
Antique Brass, Burnished, Galvanised Copper up to 7 weeks.  
Please add 10 working days for orders of more than 10 radiators.



**Vintage TRV & Pipe Covers** 

**SAVE £45\***  
WHEN YOU BUY OUR VINTAGE TRV & PIPE COVERS WITH ANY CAST IRON PURCHASE. QUOTE **PROMOV2** AT TIME OF ORDER.

For all Vintagee TRV finishes

## Stamford Sectional options

Free standing with footed ends only

### RAL & Special Finishes (White, Soft Gold, Flat Black)

2 Column

Height A (mm)	Width B (mm)	Model	Watts Δt 50°C	Btu's Δt 50°C	RAL Colours Ex VAT	RAL Colours Inc VAT	Special Finishes Ex VAT	Special Finishes Inc VAT
DELIVERY TIMES					UP TO 5 WEEKS		UP TO 5 WEEKS	
640	82	STAM2C640	73	249	£117.87	£141.44	£117.87	£141.44



White



Soft Gold\*



Slate Grey\*

Please specify your finish at time of order, delivery time is 5 weeks

### Burnished Finishes

2 Column

Height A (mm)	Width B (mm)	Model	Watts Δt 50°C	Btu's Δt 50°C	Burnished Ex VAT	Burnished Inc VAT
DELIVERY TIMES					UP TO 7 WEEKS	
640	82	STAM2C640	73	249	£142.71	£171.25



Burnished

Please specify your finish at time of order, delivery time is 7 weeks

### Antique Brass & Galvanised Finish Antique Copper

If selecting Antique Brass please read page 191 regarding the below finish.

2 Column

Height A (mm)	Width B (mm)	Model	Watts Δt 50°C	Btu's Δt 50°C	Antique Brass Ex VAT	Antique Brass Inc VAT	Galvanic Copper Ex VAT	Galvanic Copper Inc VAT
DELIVERY TIMES					UP TO 7 WEEKS		UP TO 7 WEEKS	
640	82	STAM2C640	73	249	£142.71	£171.25	£173.96	£208.75



Antique Brass



Galvanised Copper

\*Images of the Linton are for reference purposes only.  
Please specify your finish at time of order, delivery time is 7 weeks for Antique Brass and Galvanised Antique Copper.

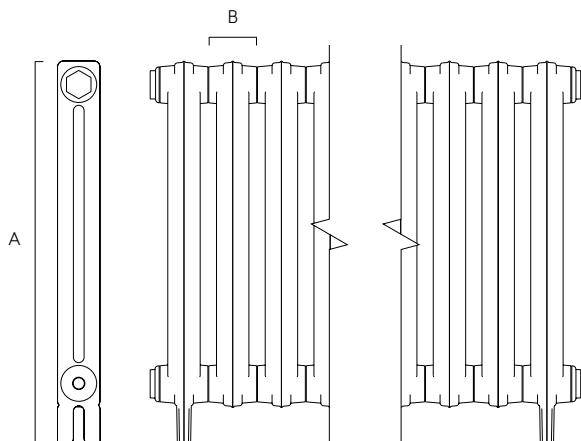

Stamford	Pipe centres left to right	Pipe centres from wall	Depth from wall
2 Column	82mm x sections plus 32mm plus valves	120mm	210mm

\*Saving based on the value of individual items when bought separately. Order any of our selected valves & matching pipe covers at the same time as your radiator.



# Trieste shown on pages 84-85



New Colours

Cast Iron; 2 or 3 column footed ends only  
CE/UKCA approved & certified to BS EN442.



Supplied in a standard primer, ready to be painted in your desired finish  
24 RAL colours (shown on page 216), 29 special finishes & 6 new feature finishes.  
Please call **01342 302250** for a RAL or Special Finish chart.  
Colour Coordination Service available, see page 217 for full details.

**Stock Primer: 5-7 working days.** RAL colours & special/feature finishes: up to 3 weeks. Please add 10 working days for orders of more than 10 radiators.



**Vintage TRV & Pipe Covers**

**SAVE £45\***  
WHEN YOU BUY OUR VINTAGE TRV & PIPE COVERS WITH ANY CAST IRON PURCHASE. QUOTE PROMOV2 AT TIME OF ORDER.

For all Vintage TRV finishes

## Trieste sectional options with footed end sections

Build your radiator to fit your requirements using individual sections shown below, visit page 184 to help you size your radiator. If you require more than 40 sections please contact our Customer Services team on 01342 302250.

### 2 Column

Height A (mm)	Width B (mm)	Model	Watts Δt 50°C	Btu's Δt 50°C	Primer Ex VAT	Primer Inc VAT	RAL Colours Ex VAT	RAL Colours Inc VAT	Special & Feature Finishes Ex VAT	Special & Feature Finishes Inc VAT
DELIVERY TIMES					<b>5-7 WORKING DAYS</b>		UP TO 3 WEEKS		UP TO 3 WEEKS	
661	76	NTRIE2C66	130	444	<b>£117.90</b>	<b>£141.48</b>	£170.96	£205.15	£186.28	£223.54
760	76	NTRIE2C76	143	488	<b>£128.81</b>	<b>£154.57</b>	£186.77	£224.12	£203.52	£244.22
955	76	NTRIE2C95	168	573	<b>£170.51</b>	<b>£204.61</b>	£247.24	£296.69	£269.41	£323.29

### 2 Column Mini Trieste

Height A (mm)	Width B (mm)	Model	Watts Δt 50°C	Btu's Δt 50°C	Primer Ex VAT	Primer Inc VAT	RAL Colours Ex VAT	RAL Colours Inc VAT	Special & Feature Finishes Ex VAT	Special & Feature Finishes Inc VAT
DELIVERY TIMES					<b>5-7 WORKING DAYS</b>		UP TO 3 WEEKS		UP TO 3 WEEKS	
514	76	NMINTRIE2C51	110	375	<b>£77.99</b>	<b>£93.59</b>	£113.09	£135.71	£123.22	£147.86

### 3 Column

Height A (mm)	Width B (mm)	Model	Watts Δt 50°C	Btu's Δt 50°C	Primer Ex VAT	Primer Inc VAT	RAL Colours Ex VAT	RAL Colours Inc VAT	Special & Feature Finishes Ex VAT	Special & Feature Finishes Inc VAT
DELIVERY TIMES					<b>5-7 WORKING DAYS</b>		UP TO 3 WEEKS		UP TO 3 WEEKS	
768	78	NTRIE3C76	189	645	<b>£136.63</b>	<b>£163.96</b>	£198.11	£237.73	£215.88	£259.06
961	78	NTRIE3C96	221	754	<b>£180.92</b>	<b>£217.10</b>	£262.33	£314.80	£285.85	£343.02

### Feature Finishes

Please call customer services for sample swatches.

**New**

The Trieste is a free standing radiator and is supplied with footed end sections only.

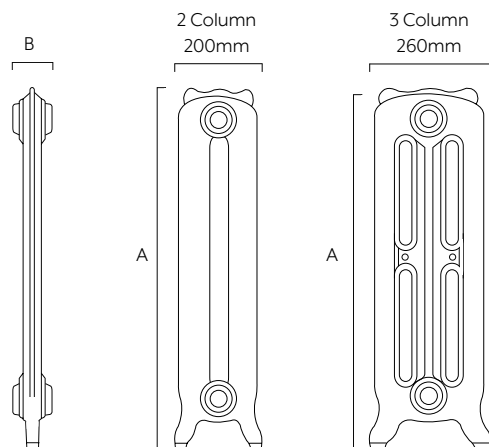

Trieste	Pipe centres left to right	Pipe centres from wall
2 Column	76 x number of sections + 24mm bushes + valves	As a free standing radiator, pipe centres depend on final position.
3 Column	78 x number of sections + 24mm bushes + valves	As a free standing radiator, pipe centres depend on final position.

\*Saving based on the value of individual items when bought separately. Order any of our selected valves & matching pipe covers at the same time as your radiator.

Some of the 29 Special Finishes the Trieste is available in, please call **01342 302250** for our special finish chart



# Bohemia shown on pages 86-87

Cast Iron; 2 column footed ends only  
CE/UKCA approved & certified to BS EN442.

24 RAL colours (shown on page 216), 4 special finishes, Burnished finish plus 1 Galvanised finish (details below).

Please call **01342 302250** for a RAL chart.

Made to order: RAL colours, Soft Gold, Slate Grey, Flat Black up to 5 weeks.

Burnished, Antique Brass and Galvanised Copper up to 7 weeks.

Please add 10 working days for orders of more than 10 radiators.



**Vintage TRV & Pipe Covers**

**SAVE £45\***  
WHEN YOU BUY OUR VINTAGE TRV & PIPE COVERS WITH ANY CAST IRON PURCHASE. QUOTE **PROMOV2** AT TIME OF ORDER.

For all Vintage TRV finishes

## Bohemia Sectional options

2 column free standing with footed ends only

### RAL & Special Finishes (Soft Gold, Slate Grey, Flat Black)

Height A (mm)	Width B (mm)	Model	Watts Δt 50°C	Btu's Δt 50°C	RAL Colours Ex VAT	RAL Colours Inc VAT	Special Finishes Ex VAT	Special Finishes Inc VAT
DELIVERY TIMES					UP TO 5 WEEKS		UP TO 5 WEEKS	
520	82	BOHE2C520	86	293	£147.34	£176.81	£154.86	£185.83
720	82	BOHE2C720	120	409	£202.16	£242.59	£211.76	£254.11
920	82	BOHE2C920	149	508	£252.45	£302.94	£264.89	£317.87



Soft Gold

Slate Grey

Flat Black

Please specify your finish at time of order, delivery time is 5 weeks

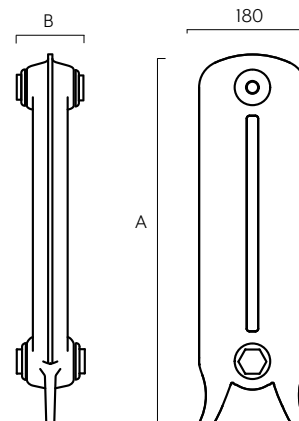

Pipe centres left to right	Pipe centres from wall	Depth from wall
82 x number of sections + 32mm + valves	120mm	210mm

### Burnished Finish

Height A (mm)	Width B (mm)	Model	Watts Δt 50°C	Btu's Δt 50°C	Burnished Ex VAT	Burnished Inc VAT
DELIVERY TIMES					UP TO 7 WEEKS	
520	82	BOHE2C520	86	293	£162.15	£194.58
720	82	BOHE2C720	120	409	£224.13	£268.96
920	82	BOHE2C920	149	508	£277.29	£332.75

Please specify your finish at time of order, delivery time is 7 weeks

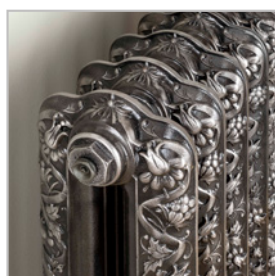

Burnished

### Antique Brass & Galvanised Finish Antique Copper

Height A (mm)	Width B (mm)	Model	Watts Δt 50°C	Btu's Δt 50°C	Antique Brass Ex VAT	Antique Brass Inc VAT	Galvanic Copper Ex VAT	Galvanic Copper Inc VAT
DELIVERY TIMES					UP TO 7 WEEKS		UP TO 7 WEEKS	
520	82	BOHE2C520	86	293	£225.10	£270.12	£226.25	£271.50
720	82	BOHE2C720	120	409	£278.73	£334.48	£309.46	£371.35
920	82	BOHE2C920	149	508	£309.71	£371.65	£389.73	£467.68

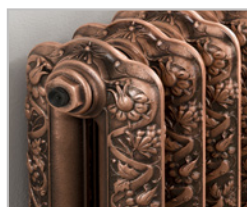

Galvanised Copper

Please specify your finish at time of order, delivery time is 7 weeks for Antique Brass, 7 weeks for Galvanised Antique Copper.



#### Antique Brass (see page 191 for more details)

Cast iron is a classic favourite, loved for its traditional qualities and style. Part of the charm of cast iron is the inherent imperfections and idiosyncrasies in the metal produced by the traditional production methods. Newly cast product retains the texture and individuality of radiators cast over 100 years ago, but in order to create an aged appearance to the finish, they go through a number of stages ending with a hand-finished application. The appeal of an antique product is its unique patina developed over time, each radiator will differ and so to reproduce that effect our Antique finishes will have a varying depth of light and dark across the radiator. After cleaning, priming and the application of the brass effect powder coat each radiator has an antique rub applied by hand. This is then rubbed down and baked to fix the protective surface. The level and amount of light and dark differ from section to section as the combination of texture, casting marks and the random nature of hand finishing produces a striking and unique antiqued finish.

\*Saving based on the value of individual items when bought separately. Order any of our selected valves & matching pipe covers at the same time as your radiator; PROMOV3W (white), PROMOV3C (chrome).

# Athena BDO shown on page 92

Steel; Slimline horizontal towel rail  
CE/UKCA approved & certified to BS EN442.

White RAL 9016 as standard, 188 RAL Colours and 30 Special Finishes.  
Please call **01342 302250** for a RAL or Special Finish chart.

## Stock White RAL 9016: 48-72 Hours

Made to Order sizes & colours: Up to 7 weeks for White.  
Up to 8 weeks for colours.

### Stock options White RAL 9016

Height (mm)	Width (mm)	Model	Watts Δt 50°C	Btu's Δt 50°C	White Ex VAT	White Inc VAT	Colours Ex VAT	Colours Inc VAT
DELIVERY TIMES					48-72 HOURS		UP TO 8 WEEKS	
370	1200	ATHEBDO3712	444	1515	£547.00	£656.40	£683.75	£820.50
455	1200	ATHEBDO4512	539	1839	£581.00	£697.20	£726.25	£871.50
	1500	ATHEBDO4515	647	2208	£628.00	£753.60	£785.00	£942.00
540	1200	ATHEBDO5412	617	2105	£614.00	£736.80	£767.50	£921.00
	1500	ATHEBDO5415	736	2511	£667.00	£800.40	£833.75	£1,000.50

Made to order options

Height (mm)	Width (mm)	Model	Watts Δt 50°C	Btu's Δt 50°C	White Ex VAT	White Inc VAT	Colours Ex VAT	Colours Inc VAT
DELIVERY TIMES					UP TO 7 WEEKS		UP TO 8 WEEKS	
370	1000	ATHEBDO3710	355	1211	£517.00	£620.40	£646.25	£775.50
	1500	ATHEBDO3715	534	1822	£590.00	£708.00	£737.50	£885.00
455	1000	ATHEBDO4510	431	1471	£549.00	£658.80	£686.25	£823.50
540	1000	ATHEBDO5410	498	1699	£578.00	£693.60	£722.50	£867.00

\*Saving based on the value of individual items when bought separately. Order any of our selected valves & matching pipe covers at the same time as your radiator; PROMOV3W (white), PROMOV3C (chrome).



**Cylinder Valve & Pipe Covers**

**SAVE £45\***  
WHEN YOU BUY OUR CYLINDER VALVE & PIPE COVERS WITH ANY TOWEL RAIL PURCHASE. QUOTE PROMOV3 AT TIME OF ORDER.

Available in White or Chrome

Pipe centres left to right	Pipe centres from wall	Depth from wall
width - 70mm	45mm to 53mm	67mm to 75mm

67-75  
45-53

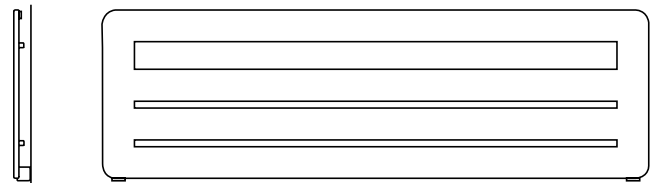

# Athena Towel Rail shown on page 93

Steel; Slimline towel rail  
CE/UKCA approved & certified to BS EN442.

White RAL 9016 as standard, 188 RAL Colours and 30 Special Finishes.  
Please call **01342 302250** for a RAL or Special Finish chart.

## Stock White RAL 9016: 48-72 Hours

Made to Order sizes & colours: Up to 7 weeks for White.  
Up to 8 weeks for colours.

Pipe centres left to right	Pipe centres from wall	Depth from wall
width - 70mm	45mm to 53mm	67mm to 75mm

### Stock options White RAL 9016

Height (mm)	Width (mm)	Model	Watts Δt 50°C	Btu's Δt 50°C	White Ex VAT	White Inc VAT	Colours Ex VAT	Colours Inc VAT
DELIVERY TIMES					48-72 HOURS		UP TO 8 WEEKS	
920	500	ATHETR9250	396	1351	£584.00	£700.80	£730.00	£876.00
1260	500	ATHETRI250	532	1815	£689.00	£826.80	£861.25	£1,033.50

Made to order options

Height (mm)	Width (mm)	Model	Watts Δt 50°C	Btu's Δt 50°C	White Ex VAT	White Inc VAT	Colours Ex VAT	Colours Inc VAT
DELIVERY TIMES					UP TO 7 WEEKS		UP TO 8 WEEKS	
1600	500	ATHETRI650	678	2313	£829.00	£994.80	£1,036.25	£1,243.50



**Cylinder Valve & Pipe Covers**

**SAVE £45\***  
WHEN YOU BUY OUR CYLINDER VALVE & PIPE COVERS WITH ANY TOWEL RAIL PURCHASE. QUOTE PROMOV3 AT TIME OF ORDER.

Available in White or Chrome

67-75  
45-53

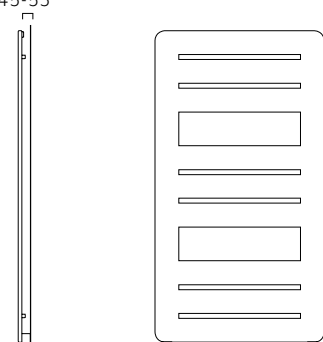

# Step BDO shown on page 90

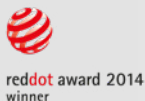

High quality Italian design & manufacture  
Aluminium; horizontal towel rail  
10 year guarantee, CE/UKCA approved & certified to BS EN442.

White Pearl & Chrome

Made to Order:  
Up to 5 weeks: White Pearl & Chrome



**Cylinder Valve & Pipe Covers** 

**SAVE £45\***  
WHEN YOU BUY OUR CYLINDER VALVE & PIPE COVERS WITH ANY TOWEL RAIL PURCHASE. QUOTE PROMOV3 AT TIME OF ORDER.

Available in White or Chrome

Pipe centres left to right	Pipe centres from wall	Depth from wall
width - 224mm	60mm - 67mm	107mm - 114mm

Made to order options - White Pearl

Height (mm)	Width (mm)	Model	Watts Δt 50°C	Btu's Δt 50°C	White Pearl Ex VAT	White Pearl Inc VAT
DELIVERY TIMES			UP TO 5 WEEKS			
310	1500	STEBDO3115WP	466	1590	£1,465.00	£1,758.00
	1800	STEBDO3118WP	559	1907	£1,496.00	£1,795.20
430	1500	STEBDO4315WP	624	2129	£1,747.00	£2,096.40
	1800	STEBDO4318WP	749	2556	£1,977.00	£2,372.40

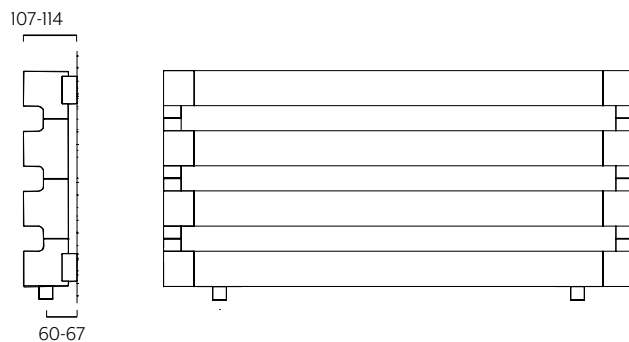

Made to order options - Chrome

Height (mm)	Width (mm)	Model	Watts Δt 50°C	Btu's Δt 50°C	Chrome Ex VAT	Chrome Inc VAT
DELIVERY TIMES			UP TO 5 WEEKS			
310	1500	STEBDO3115	326	1112	£1,640.00	£1,968.00
	1800	STEBDO3118	391	1334	£1,905.00	£2,286.00
430	1500	STEBDO4315	436	1488	£2,020.00	£2,424.00
	1800	STEBDO4318	524	1788	£2,611.00	£3,133.20



Chrome

\*Saving based on the value of individual items when bought separately. Order any of our selected valves & matching pipe covers at the same time as your radiator; PROMOV3W (white), PROMOV3C (chrome).

# Step shown on page 91



reddot award 2014  
winner



High quality Italian design & manufacture  
Aluminium; vertical ladder rail. Hydronic & Electric models  
10 year guarantee, CE/UKCA approved & certified to BS EN442.

White Pearl & Chrome

Made to Order:

Up to 5 weeks: White Pearl & Chrome

Up to 5 weeks for White Pearl electric, 7 weeks for Chrome



Cylinder Valve  
& Pipe  
Covers



**SAVE £45\***

WHEN YOU BUY OUR CYLINDER VALVE & PIPE COVERS WITH ANY TOWEL RAIL PURCHASE. QUOTE PROMOV3 AT TIME OF ORDER.

Available in White or Chrome

Pipe centres left to right	Pipe centres from wall	Depth from wall
width - 224mm	60mm - 67mm	107mm - 114mm

Made to order options - White Pearl



Height (mm)	Width (mm)	Model	Watts Δt 50°C	Btu's Δt 50°C	White Pearl Ex VAT	White Pearl Inc VAT
DELIVERY TIMES					UP TO 5 WEEKS	
760	500	STEP7650WP	370	1262	£1,788.00	£2,145.60
	600	STEP7660WP	421	1436	£1,811.00	£2,173.20
1240	500	STEP1250WP	598	2040	£2,459.00	£2,950.80
	600	STEP1260WP	653	2228	£2,479.00	£2,974.80
1720	500	STEP1750WP	816	2784	£3,112.00	£3,734.40
	600	STEP1760WP	935	3190	£3,160.00	£3,792.00

107-114 [ ] 60-67

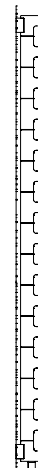
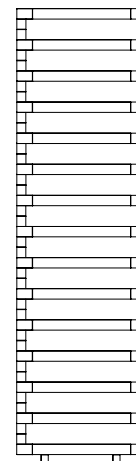
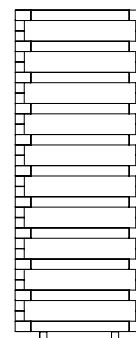
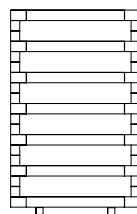

Made to order options - Chrome



Height (mm)	Width (mm)	Model	Watts Δt 50°C	Btu's Δt 50°C	Chrome Ex VAT	Chrome Inc VAT
DELIVERY TIMES					UP TO 5 WEEKS	
760	500	STEP7650	273	931	£1,932.00	£2,318.40
	600	STEP7660	304	1037	£1,988.00	£2,385.60
1240	500	STEP1250	404	1378	£2,729.00	£3,274.80
	600	STEP1260	472	1610	£2,822.00	£3,386.40
1720	500	STEP1750	577	1969	£3,534.00	£4,240.80
	600	STEP1760	653	2228	£3,655.00	£4,386.00

Made to order options - Electric

Height (mm)	Width (mm)	Model	Watts Δt 50°C	White Pearl Ex VAT	White Pearl Inc VAT	Chrome Ex VAT	Chrome Inc VAT
DELIVERY TIMES			UP TO 5 WEEKS		UP TO 7 WEEKS		
775	500	STEP7750E	250	£2,151.00	£2,581.20	£3,097.00	£3,716.40
1255	500	STEP1250E	450	£2,782.00	£3,338.40	£4,258.00	£5,109.60
1735	500	STEP1750E	650	£3,427.00	£4,112.40	£5,433.00	£6,519.60

The Step Electric has a number of functions that gives you complete control. You can set the desired temperature in adjustments from 7°C to 31°C, there is a boost facility that delivers maximum power for 2 hours. It also has infrared capabilities for weekly programming, comfort and night-time modes, via remote control.



\*Saving based on the value of individual items when bought separately. Order any of our selected valves & matching pipe covers at the same time as your radiator; PROMOV3W (white), PROMOV3C (chrome).

# Relax Bagno shown on page 94

High quality Italian design & manufacture

Steel; round tube radiator with a steel flat cover, underneath connections only  
CE/UKCA approved & certified to BS EN442.

White RAL 9016 standard, 188 RAL Colours, 30 Special Finishes + Polished Stainless Steel.  
Please call **01342 302250** for a RAL or Special Finish chart

**Stock sizes: White RAL 9016 delivered in 48-72 hours,**

Made to Order sizes & colours: Up to 5 weeks, Polished in up to 8 weeks



Cylinder Valve & Pipe Covers



**SAVE £45\***

WHEN YOU BUY OUR CYLINDER VALVE & PIPE COVERS WITH ANY TOWEL RAIL PURCHASE. QUOTE PROMOV3 AT TIME OF ORDER.

Available in White or Chrome

Single / Double	Pipe centres left to right	Pipe centres from wall	Depth from wall
Single	width - 109mm	55mm - 65mm	148mm - 158mm
Double	width - 109mm	79mm - 89mm	172mm - 182mm

## Stock options White RAL 9016 - Single

Height (mm)	Width (mm)	Model	Watts Δt 50°C	Btu's Δt 50°C	White Ex VAT	White Inc VAT	Colours Ex VAT	Colours Inc VAT
DELIVERY TIMES					48-72 HOURS		UP TO 5 WEEKS	
1853	517	RELBASV1851	1178	4019	£1,857.00	£2,228.40	£2,321.25	£2,785.50
	653	RELBASV1865	1519	5183	£1,960.00	£2,352.00	£2,450.00	£2,940.00

## Stock options White RAL 9016 - Double

Height (mm)	Width (mm)	Model	Watts Δt 50°C	Btu's Δt 50°C	White Ex VAT	White Inc VAT	Colours Ex VAT	Colours Inc VAT
DELIVERY TIMES					48-72 HOURS		UP TO 5 WEEKS	
1853	517	RELBADV1851	1477	5040	£2,145.00	£2,574.00	£2,681.25	£3,217.50
	653	RELBADV1865	1817	6200	£2,459.00	£2,950.80	£3,073.75	£3,688.50

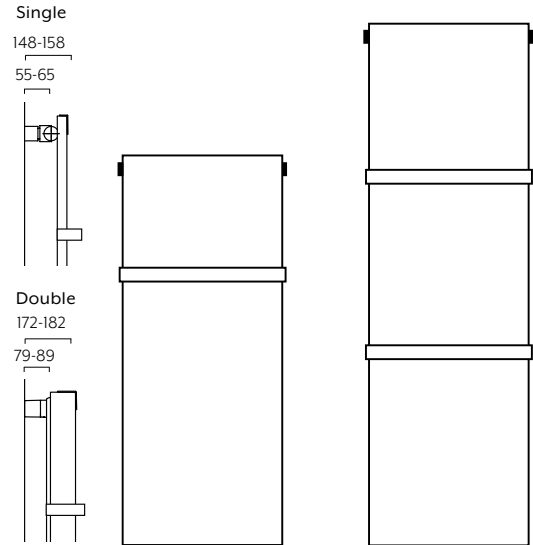

Please note: 1553mm high models have 1 chrome towel bar, 1853mm high models have 2 chrome bars.

Made to order options - Single white & colours

Height (mm)	Width (mm)	Model	Watts Δt 50°C	Btu's Δt 50°C	White Ex VAT	White Inc VAT	Colours Ex VAT	Colours Inc VAT
DELIVERY TIMES					UP TO 5 WEEKS		UP TO 5 WEEKS	
1553	381	RELBASV1538	699	2385	£1,188.00	£1,425.60	£1,485.00	£1,782.00
	517	RELBASV1551	984	3357	£1,300.00	£1,560.00	£1,625.00	£1,950.00
	653	RELBASV1565	1269	4330	£1,389.00	£1,666.80	£1,736.25	£2,083.50
1853	381	RELBASV1838	837	2856	£1,629.00	£1,954.80	£2,036.25	£2,443.50

Made to order options - Double white & colours

Height (mm)	Width (mm)	Model	Watts Δt 50°C	Btu's Δt 50°C	White Ex VAT	White Inc VAT	Colours Ex VAT	Colours Inc VAT
DELIVERY TIMES					UP TO 5 WEEKS		UP TO 5 WEEKS	
1553	381	RELBADV1538	1017	3470	£1,465.00	£1,758.00	£1,831.25	£2,197.50
	517	RELBADV1551	1431	4883	£1,569.00	£1,882.80	£1,961.25	£2,353.50
	653	RELBADV1565	1591	5428	£1,668.00	£2,001.60	£2,085.00	£2,502.00
1853	381	RELBADV1838	1050	3583	£1,917.00	£2,300.40	£2,396.25	£2,875.50

Made to order options - Single Polished Stainless Steel

Height (mm)	Width (mm)	Model	Watts Δt 50°C	Btu's Δt 50°C	Polished Stainless Steel Ex VAT	Polished Stainless Steel Inc VAT
DELIVERY TIMES					UP TO 8 WEEKS	
1553	381	RELBASV1538	489	1668	£2,627.00	£3,152.40
	517	RELBASV1551	689	2351	£2,774.00	£3,328.80
	653	RELBASV1565	888	3030	£2,878.00	£3,453.60
1853	381	RELBASV1838	586	1999	£3,414.00	£4,096.80
	517	RELBASV1851	825	2815	£3,670.00	£4,404.00
	653	RELBASV1865	1063	3627	£3,875.00	£4,650.00

Made to order options - Double Polished Stainless Steel

Height (mm)	Width (mm)	Model	Watts Δt 50°C	Btu's Δt 50°C	Polished Stainless Steel Ex VAT	Polished Stainless Steel Inc VAT
DELIVERY TIMES					UP TO 8 WEEKS	
1553	381	RELBADV1538	712	2429	£3,487.00	£4,184.40
	517	RELBADV1551	1002	3419	£3,595.00	£4,314.00
	653	RELBADV1565	1114	3801	£3,812.00	£4,574.40
1853	381	RELBADV1838	735	2508	£4,402.00	£5,282.40
	517	RELBADV1851	1034	3528	£4,727.00	£5,672.40
	653	RELBADV1865	1272	4340	£4,935.00	£5,922.00

\*Saving based on the value of individual items when bought separately. Order any of our selected valves & matching pipe covers at the same time as your radiator; PROMOV3W (white), PROMOV3C (chrome).

# Echo shown on page 95

Steel; Side loading towel rail, 50mm x 10mm flat tubes  
Can be installed left or right-handed  
CE/UKCA approved & certified to BS EN442.

White RAL 9016 as standard, 188 RAL Colours and 30 Special Finishes  
Please call **01342 302250** for a RAL or Special Finish chart.

## Stock White RAL 9016: 48-72 Hours

Made to Order sizes & colours: Up to 7 weeks White & White Electric,  
Up to 8 weeks Colours.

### Stock options White RAL 9016- Hydronic

Height (mm)	Width (mm)	Model	Watts Δt 50°C	Btu's Δt 50°C	White Ex VAT	White Inc VAT	Colours Ex VAT	Colours Inc VAT
DELIVERY TIMES					48-72 HOURS		UP TO 8 WEEKS	
850	500	ECHO8550	585	1996	£496.00	£595.20	£620.00	£744.00
1110	500	ECHO1150	764	2607	£616.00	£739.20	£770.00	£924.00

Made to order options - Hydronic

Height (mm)	Width (mm)	Model	Watts Δt 50°C	Btu's Δt 50°C	White Ex VAT	White Inc VAT	Colours Ex VAT	Colours Inc VAT
DELIVERY TIMES					UP TO 7 WEEKS		UP TO 8 WEEKS	
655	500	ECHO6550	450	1535	£417.00	£500.40	£521.25	£625.50
	600	ECHO6560	506	1726	£434.00	£520.80	£542.50	£651.00
850	600	ECHO8560	655	2235	£518.00	£621.60	£647.50	£777.00
1110	600	ECHO1160	857	2924	£648.00	£777.60	£810.00	£972.00
1695	500	ECHO1650	1167	3982	£868.00	£1,041.60	£1,085.00	£1,302.00
	600	ECHO1660	1310	4470	£916.00	£1,099.20	£1,145.00	£1,374.00

\*Saving based on the value of individual items when bought separately. Order any of our selected valves & matching pipe covers at the same time as your radiator; PROMOV3W (white), PROMOV3C (chrome).



Cylinder Valve & Pipe Covers



**SAVE £45\***

WHEN YOU BUY OUR CYLINDER VALVE & PIPE COVERS WITH ANY TOWEL RAIL PURCHASE. QUOTE PROMOV3 AT TIME OF ORDER.

Available in White or Chrome

Made to order options - Electric

Pipe centres left to right	Height (mm)	Width (mm)	Model	Watts Δt 50°C	White Ex VAT	White Inc VAT
50mm	DELIVERY TIMES					
Pipe centres from wall	850	500	ECHO8550EW	600	£640.00	£768.00
		600	ECHO8560EW	600	£661.00	£793.20
57mm - 65mm	1110	500	ECHO1150EW	800	£754.00	£904.80
		600	ECHO1160EW	800	£783.00	£939.60
Depth from wall	1695	500	ECHO1650EW	1200	£995.00	£1,194.00
		600	ECHO1660EW	1200	£1,039.00	£1,246.80
112mm - 120mm	UP TO 7 WEEKS					

Supplied as standard with a MOA Element

- 5 heat settings from 30°C to 60°C regulating internal radiator temperature, denoted by 5 LEDs. No Timer.
- Compatible with external Timer as remembers settings when turned off
- 55mm diameter clock shaped face.
- 4x Buttons: Temperature +/-, Dryer, Power. Frost & overheating protection.
- Straight cable, no plug. IPx5. Class I. Guarantee - 2 years.

# Piano Lato shown on page 97

High quality Italian design & manufacture  
Steel; side loading towel rail  
CE/UKCA approved & certified to BS EN442.

White RAL 9016 as standard, 188 RAL Colours and 30 Special Finishes  
Please call **01342 302250** for a RAL or Special Finish chart.

## Stock White RAL 9016: 48-72 Hours

Made to Order sizes & colours: Up to 5 weeks.



Cylinder Valve & Pipe Covers



**SAVE £45\***

WHEN YOU BUY OUR CYLINDER VALVE & PIPE COVERS WITH ANY TOWEL RAIL PURCHASE. QUOTE PROMOV3 AT TIME OF ORDER.

Available in White or Chrome

Pipe centres left to right	Pipe centres from wall	Depth from wall
50mm	57mm - 67mm	80mm - 90mm

### Stock options White RAL 9016

Height (mm)	Width (mm)	Model	Watts Δt 50°C	Btu's Δt 50°C	White Ex VAT	White Inc VAT	Colours Ex VAT	Colours Inc VAT
DELIVERY TIMES					48-72 HOURS		UP TO 5 WEEKS	
1260	550	PIALAT1255	524	1788	£506.00	£607.20	£632.50	£759.00
1596	550	PIALAT1555	654	2231	£617.00	£740.40	£771.25	£925.50

\*Saving based on the value of individual items when bought separately. Order any of our selected valves & matching pipe covers at the same time as your radiator; PROMOV3W (white), PROMOV3C (chrome).

80-90  
57-67



75 425

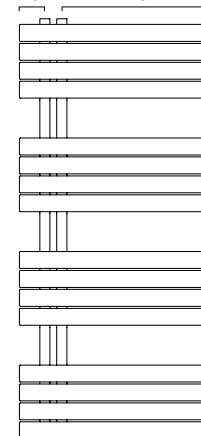

# Piano Towel Rail shown on page 96

High quality Italian design & manufacture  
Steel; 50mm x 10mm flat tubes with 30mm collectors  
CE/UKCA approved & certified to BS EN442.

White RAL 9016 as standard, 188 RAL colours plus 30 Special Finishes  
Please call **01342 302250** for a RAL or Special Finish chart.

## Stock White RAL 9016: 48-72 Hours

Made to Order sizes & colours: Up to 5 weeks.

Pipe centres left to right	Pipe centres from wall	Depth from wall
width - 50mm	55mm	78mm



**Cylinder Valve & Pipe Covers** 

**SAVE £45\***  
WHEN YOU BUY OUR CYLINDER VALVE & PIPE COVERS WITH ANY TOWEL RAIL PURCHASE. QUOTE PROMOV3 AT TIME OF ORDER.

Available in White or Chrome

## Stock options White RAL 9016

Height (mm)	Width (mm)	Model	Watts Δt 50°C	Btu's Δt 50°C	White Ex VAT	White Inc VAT	Colours Ex VAT	Colours Inc VAT
DELIVERY TIMES					48-72 HOURS		UP TO 5 WEEKS	
792	506	PIATR7950	412	1406	£303.00	£363.60	£378.75	£454.50
	606	PIATR7960	483	1648	£309.00	£370.80	£386.25	£463.50
1156	506	PIATR1150	558	1904	£371.00	£445.20	£463.75	£556.50
	606	PIATR1160	658	2245	£377.00	£452.40	£471.25	£565.50
1520	506	PIATR1550	718	2450	£422.00	£506.40	£527.50	£633.00
	606	PIATR1560	848	2893	£435.00	£522.00	£543.75	£652.50

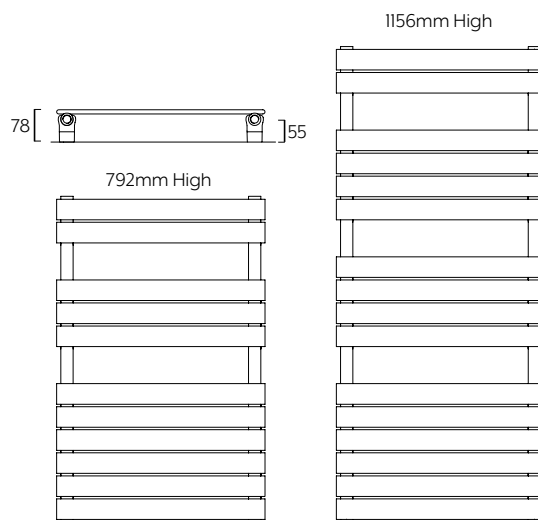

## Made to order options

Height (mm)	Width (mm)	Model	Watts Δt 50°C	Btu's Δt 50°C	White Ex VAT	White Inc VAT	Colours Ex VAT	Colours Inc VAT
DELIVERY TIMES					UP TO 5 WEEKS		UP TO 5 WEEKS	
792	456	PIATR7945	377	1286	£300.00	£360.00	£375.00	£450.00
	556	PIATR7955	447	1525	£304.00	£364.80	£380.00	£456.00
	756	PIATR7975	588	2006	£317.00	£380.40	£396.25	£475.50
1156	456	PIATR1145	507	1730	£365.00	£438.00	£456.25	£547.50
	556	PIATR1155	608	2074	£373.00	£447.60	£466.25	£559.50
	756	PIATR1175	808	2757	£392.00	£470.40	£490.00	£588.00
1520	456	PIATR1545	654	2231	£418.00	£501.60	£522.50	£627.00
	556	PIATR1555	783	2672	£428.00	£513.60	£535.00	£642.00
	756	PIATR1575	1043	3559	£451.00	£541.20	£563.75	£676.50
1744	456	PIATR1745	766	2614	£458.00	£549.60	£572.50	£687.00
	506	PIATR1750	839	2863	£464.00	£556.80	£580.00	£696.00
	556	PIATR1755	912	3112	£469.00	£562.80	£586.25	£703.50
	606	PIATR1760	986	3364	£472.00	£566.40	£590.00	£708.00
	756	PIATR1775	1206	4115	£494.00	£592.80	£617.50	£741.00

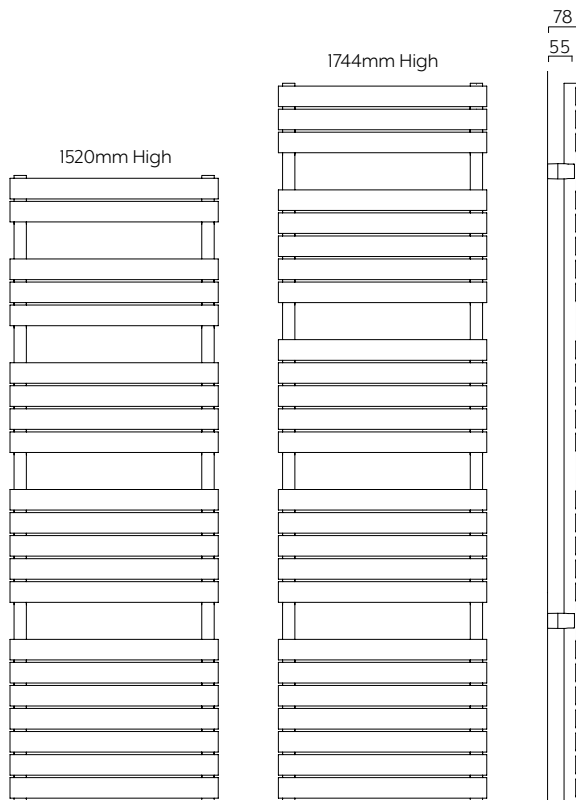

\*Saving based on the value of individual items when bought separately. Order any of our selected valves & matching pipe covers at the same time as your radiator; PROMOV3W (white), PROMOV3C (chrome).



# Quadre shown on page 98



High quality Italian design & manufacture  
Steel; 25mm x 20mm rectangular tubes with 30mm square collectors  
CE/UKCA approved & certified to BS EN442.

White RAL 9016 as standard, 188 RAL Colours and 30 Special Finishes  
Please call **01342 302250** for a RAL or Special Finish chart.

## Stock White RAL 9016: 48-72 Hours

Made to Order sizes & colours: Up to 5 weeks.



**SAVE £45\***  
WHEN YOU BUY OUR CYLINDER VALVE & PIPE COVERS WITH ANY TOWEL RAIL PURCHASE. QUOTE PROMOV3 AT TIME OF ORDER.

Available in White or Chrome

Pipe centres left to right	Pipe centres from wall	Depth from wall
width - 30mm	58mm to 68mm	73mm to 83mm

## Stock options White RAL 9016

Height (mm)	Width (mm)	Model	Watts Δt 50°C	Btu's Δt 50°C	White Ex VAT	White Inc VAT	Colours Ex VAT	Colours Inc VAT
DELIVERY TIMES					48-72 HOURS		UP TO 5 WEEKS	
1216	430	QUADI243	507	1730	£255.00	£306.00	£318.75	£382.50
	580	QUADI258	667	2276	£279.00	£334.80	£348.75	£418.50

Made to order options - Hydronic

Height (mm)	Width (mm)	Model	Watts Δt 50°C	Btu's Δt 50°C	White Ex VAT	White Inc VAT	Colours Ex VAT	Colours Inc VAT
DELIVERY TIMES					UP TO 5 WEEKS		UP TO 5 WEEKS	
872	430	QUAD8743	372	1269	£223.00	£267.60	£278.75	£334.50
	530	QUAD8753	453	1546	£237.00	£284.40	£296.25	£355.50
	580	QUAD8758	493	1682	£242.00	£290.40	£302.50	£363.00
1216	530	QUADI253	613	2092	£272.00	£326.40	£340.00	£408.00
1517	430	QUADI543	652	2225	£281.00	£337.20	£351.25	£421.50
	530	QUADI553	747	2549	£303.00	£363.60	£378.75	£454.50
	580	QUADI558	812	2771	£310.00	£372.00	£387.50	£465.00
1818	430	QUADI843	801	2733	£315.00	£378.00	£393.75	£472.50
	530	QUADI853	912	3112	£339.00	£406.80	£423.75	£508.50
	580	QUADI858	992	3385	£351.00	£421.20	£438.75	£526.50

73-83 [ ] 58-68

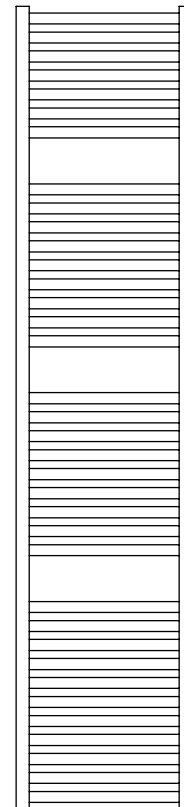
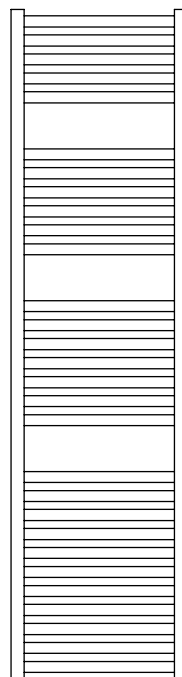
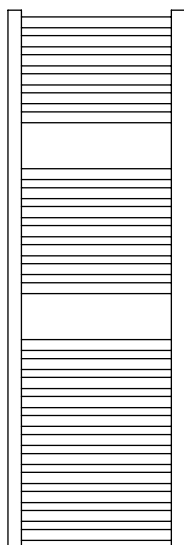
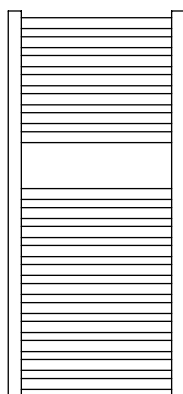

73-83  
58-68

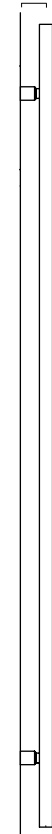

\*Saving based on the value of individual items when bought separately. Order any of our selected valves & matching pipe covers at the same time as your radiator; PROMOV3W (white), PROMOV3C (chrome).

# Griffin shown on page 99

Steel; 40mm trapezoid collectors, 32mm flat cross tubes  
Hydronic & Electric models  
CE/UKCA approved & certified to BS EN442.

White RAL 9016 as standard, 188 RAL Colours and 30 Special Finishes  
Please call **01342 302250** for a RAL or Special Finish chart.

## Stock White RAL 9016: 48-72 Hours

Made to Order White & Colours: 7 weeks for white, 8 weeks for colours  
Made to Order Electric: Up to 7 weeks.



Cylinder Valve & Pipe Covers



**SAVE £45\***

WHEN YOU BUY OUR CYLINDER VALVE & PIPE COVERS WITH ANY TOWEL RAIL PURCHASE. QUOTE PROMOV3 AT TIME OF ORDER.

Available in White or Chrome

Pipe centres left to right	Pipe centres from wall	Depth from wall
width - 43mm	60mm to 68mm	77mm to 85mm

## Stock options White RAL 9016

Height (mm)	Width (mm)	Model	Watts Δt 50°C	Btu's Δt 50°C	White Ex VAT	White Inc VAT	Colours Ex VAT	Colours Inc VAT
DELIVERY TIMES					48-72 HOURS		UP TO 8 WEEKS	
860	600	GRIF8660	464	1583	<b>£274.00</b>	<b>£328.80</b>	£342.50	£411.00
1220	400	GRIF1240	440	1501	<b>£326.00</b>	<b>£391.20</b>	£407.50	£489.00
	500	GRIF1250	541	1846	<b>£339.00</b>	<b>£406.80</b>	£423.75	£508.50
	600	GRIF1260	640	2184	<b>£350.00</b>	<b>£420.00</b>	£437.50	£525.00
1760	500	GRIF1750	762	2600	<b>£487.00</b>	<b>£584.40</b>	£608.75	£730.50

60-68 [ ] 77-85

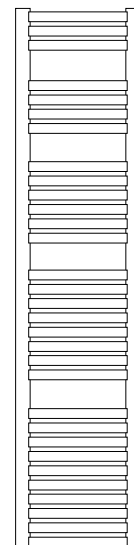
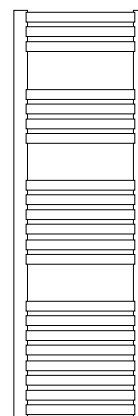
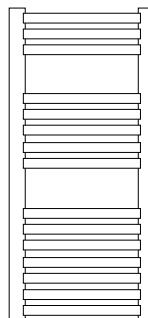

Made to order options - White & colours

Height (mm)	Width (mm)	Model	Watts Δt 50°C	Btu's Δt 50°C	White Ex VAT	White Inc VAT	Colours Ex VAT	Colours Inc VAT
DELIVERY TIMES					UP TO 7 WEEKS		UP TO 8 WEEKS	
860	400	GRIF8640	323	1102	£255.00	£306.00	£318.75	£382.50
	500	GRIF8650	394	1344	£265.00	£318.00	£331.25	£397.50
1760	400	GRIF1740	618	2109	£468.00	£561.60	£585.00	£702.00
	600	GRIF1760	906	3091	£507.00	£608.40	£633.75	£760.50

\*Saving based on the value of individual items when bought separately. Order any of our selected valves & matching pipe covers at the same time as your radiator; PROMOV3W (white), PROMOV3C (chrome).

Made to order options - Electric White

Height (mm)	Width (mm)	Model	Watts Δt 50°C	White Ex VAT	White Inc VAT
DELIVERY TIMES					
UP TO 7 WEEKS					
860	500	GRIF8650EW	400	£575.00	£690.00
	600	GRIF8660EW	600	£596.00	£715.20
1220	500	GRIF1250EW	600	£678.00	£813.60
	600	GRIF1260EW	800	£710.00	£852.00
1760	500	GRIF1750EW	800	£887.00	£1,064.40
	600	GRIF1760EW	1000	£930.00	£1,116.00



Griffin Electric option

Griffin Electric models supplied with a MOA Element:

- 5 heat settings from 30°C to 60°C to regulate the internal radiator temperature. Selected setting denoted by 5 LEDs.
- No Timer.
- Compatible with external Timer as remembers settings when turned off
- 55mm diameter clock shaped face.
- 4x Buttons: Temperature +/-, Dryer, Power.
- Frost & overheating protection.
- Straight cable, no plug. IPx5. Class 1. Guarantee - 2 years.

# Pulsar shown on page 100

High quality Italian design & manufacture.  
Steel; frame style, elliptical cross tubes  
CE/UKCA approved & certified to BS EN442.

White RAL 9016 as standard, 188 RAL Colours and 30 Special Finishes  
Please call **01342 302250** for a RAL or Special Finish chart.

## Stock White RAL 9016: 48-72 Hours

Made to Order sizes & colours: Up to 5 weeks.

Pipe centres left to right	Pipe centres from wall	Depth from wall
width - 44mm	71mm - 86mm	92mm - 107mm

## Stock options White RAL 9016

Height (mm)	Width (mm)	Model	Watts Δt 50°C	Btu's Δt 50°C	White Ex VAT	White Inc VAT	Colours Ex VAT	Colours Inc VAT
DELIVERY TIMES					48-72 HOURS		UP TO 5 WEEKS	
1224	500	PULSI250	604	2061	£455.00	£546.00	£568.75	£682.50
	600	PULSI260	710	2423	£471.00	£565.20	£588.75	£706.50

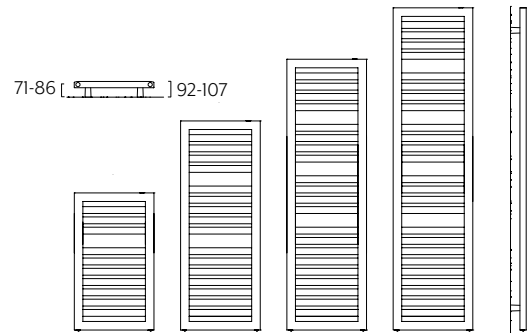

Cylinder Valve & Pipe Covers



**SAVE £45\***

WHEN YOU BUY OUR CYLINDER VALVE & PIPE COVERS WITH ANY TOWEL RAIL PURCHASE. QUOTE PROMOV3 AT TIME OF ORDER.

Available in White or Chrome

Made to order options - White & colours

Height (mm)	Width (mm)	Model	Watts Δt 50°C	Btu's Δt 50°C	White Ex VAT	White Inc VAT	Colours Ex VAT	Colours Inc VAT
DELIVERY TIMES					UP TO 5 WEEKS		UP TO 5 WEEKS	
804	450	PULS8045	374	1276	£367.00	£440.40	£458.75	£550.50
	500	PULS8050	409	1396	£373.00	£447.60	£466.25	£559.50
	600	PULS8060	479	1634	£384.00	£460.80	£480.00	£576.00
1224	450	PULSI245	551	1880	£448.00	£537.60	£560.00	£672.00
	500	PULSI545	684	2334	£550.00	£660.00	£687.50	£825.00
1584	500	PULSI550	753	2569	£576.00	£691.20	£720.00	£864.00
	600	PULSI560	892	3044	£590.00	£708.00	£737.50	£885.00
	450	PULSI845	825	2815	£648.00	£777.60	£810.00	£972.00
1884	500	PULSI850	903	3081	£672.00	£806.40	£840.00	£1,008.00
	600	PULSI860	1058	3610	£695.00	£834.00	£868.75	£1,042.50

\*Saving based on the value of individual items when bought separately. Order any of our selected valves & matching pipe covers at the same time as your radiator; PROMOV3W (white), PROMOV3C (chrome).

# Blues shown on page 112

Stainless Steel; 15mm x 30mm horizontal tubes with 30mm x 30mm collectors  
Suitable for a direct system  
CE/UKCA approved & certified to BS EN442.

Polished or Satin Stainless Steel

## Stock Polished Stainless Steel: 48-72 Hours

Made to Order Satin Stainless Steel: Up to 4 weeks

Pipe centres left to right	Pipe centres from wall	Depth from wall
50mm	55mm to 70mm	85mm to 100mm

## Stock options Polished Stainless Steel

Height (mm)	Width (mm)	Model	Watts Δt 50°C	Btu's Δt 50°C	Polished Stainless Steel Ex VAT	Polished Stainless Steel Inc VAT
DELIVERY TIMES					48-72 HOURS	
770	500	BLUE7750	236	805	£1,186.00	£1,423.20
1190	500	BLUE1150	337	1150	£1,676.00	£2,011.20
1400	500	BLUE1450	379	1293	£2,003.00	£2,403.60

Made to order options - Satin Stainless Steel

Height (mm)	Width (mm)	Model	Watts Δt 50°C	Btu's Δt 50°C	Satin Stainless Steel Ex VAT	Satin Stainless Steel Inc VAT
DELIVERY TIMES					UP TO 4 WEEKS	
770	500	BLUE7750	236	805	£798.00	£957.60
1190	500	BLUE1150	337	1150	£1,186.00	£1,423.20
1400	500	BLUE1450	379	1293	£1,390.00	£1,668.00



Cylinder Valve & Pipe Covers



**SAVE £45\***

WHEN YOU BUY OUR CYLINDER VALVE & PIPE COVERS WITH ANY TOWEL RAIL PURCHASE. QUOTE PROMOV3 AT TIME OF ORDER.

Available in White or Chrome



# Ellipsis Towel Rail shown on page 101



High quality Italian design & manufacture  
Steel; elliptical tube towel rail.  
CE/UKCA approved & certified to BS EN442.

White RAL 9016 as standard, 188 RAL Colours and 30 Special Finishes  
Please call **01342 302250** for a RAL or Special Finish chart.

## Stock White RAL 9016: 48-72 Hours

Made to Order sizes & colours: Up to 5 weeks.



Cylinder Valve & Pipe Covers



**SAVE £45\***

WHEN YOU BUY OUR CYLINDER VALVE & PIPE COVERS WITH ANY TOWEL RAIL PURCHASE. QUOTE PROMOV3 AT TIME OF ORDER.

Available in White or Chrome

Pipe centres left to right	Pipe centres from wall	Depth from wall
width - 50mm	55mm	93mm

## Stock options White RAL 9016

Height (mm)	Width (mm)	Model	Watts Δt 50°C	Btu's Δt 50°C	White Ex VAT	White Inc VAT	Colours Ex VAT	Colours Inc VAT
DELIVERY TIMES					48-72 HOURS		UP TO 5 WEEKS	
960	500	ELLITR9650	453	1546	£343.00	£411.60	£428.75	£514.50
1200	400	ELLITRI240	457	1559	£409.00	£490.80	£511.25	£613.50
	500	ELLITRI250	549	1873	£416.00	£499.20	£520.00	£624.00
	600	ELLITRI260	641	2187	£442.00	£530.40	£552.50	£663.00
1380	400	ELLITRI340	528	1802	£479.00	£574.80	£598.75	£718.50
	500	ELLITRI350	638	2177	£490.00	£588.00	£612.50	£735.00
	600	ELLITRI360	748	2552	£514.00	£616.80	£642.50	£771.00
1620	500	ELLITRI650	729	2487	£561.00	£673.20	£701.25	£841.50

Made to order options

Height (mm)	Width (mm)	Model	Watts Δt 50°C	Btu's Δt 50°C	White Ex VAT	White Inc VAT	Colours Ex VAT	Colours Inc VAT
DELIVERY TIMES					UP TO 5 WEEKS		UP TO 5 WEEKS	
960	400	ELLITR9640	371	1266	£337.00	£404.40	£421.25	£505.50
	600	ELLITR9660	534	1822	£364.00	£436.80	£455.00	£546.00
1620	400	ELLITRI640	606	2068	£550.00	£660.00	£687.50	£825.00
	600	ELLITRI660	853	2910	£590.00	£708.00	£737.50	£885.00

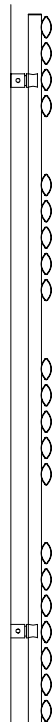
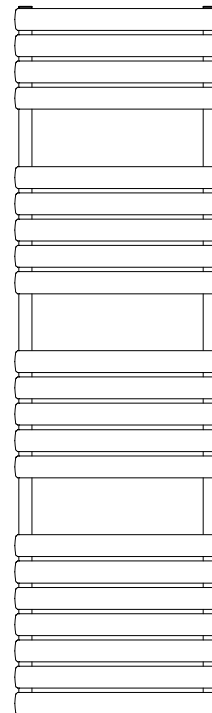
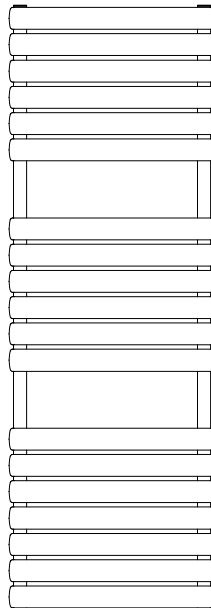
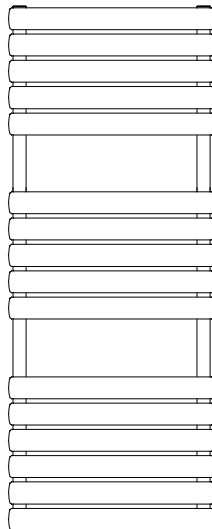
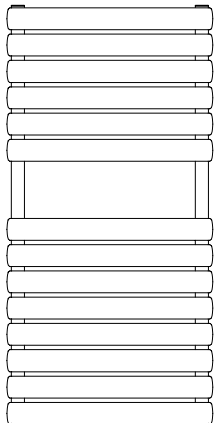
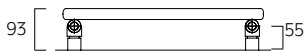

\*Saving based on the value of individual items when bought separately. Order any of our selected valves & matching pipe covers at the same time as your radiator; PROMOV3W (white), PROMOV3C (chrome).

# Sitar Lato shown on page 102

High quality Italian design & manufacture.  
Steel: 23mm cross tubes  
CE/UKCA approved & certified to BS EN442.

White RAL 9016 as standard, 188 RAL Colours and 30 Special Finishes  
Please call **01342 302250** for a RAL or Special Finish chart.

**Stock White RAL 9016: 48-72 Hours**  
Made to Order sizes & colours: Up to 5 weeks.

## Stock options White RAL 9016

Height (mm)	Width (mm)	Model	Watts Δt 50°C	Btu's Δt 50°C	White Ex VAT	White Inc VAT	Colours Ex VAT	Colours Inc VAT
DELIVERY TIMES					48-72 HOURS		UP TO 5 WEEKS	
832	500	SITLAT8350	394	1344	£331.00	£397.20	£413.75	£496.50
	600	SITLAT8360	455	1552	£341.00	£409.20	£426.25	£511.50
1348	500	SITLAT1350	612	2088	£405.00	£486.00	£506.25	£607.50
	600	SITLAT1360	708	2416	£418.00	£501.60	£522.50	£627.00

Made to order options

Height (mm)	Width (mm)	Model	Watts Δt 50°C	Btu's Δt 50°C	White Ex VAT	White Inc VAT	Colours Ex VAT	Colours Inc VAT
DELIVERY TIMES					UP TO 5 WEEKS		UP TO 5 WEEKS	
832	700	SITLAT8370	515	1757	£361.00	£433.20	£451.25	£541.50
1348	700	SITLAT1370	801	2733	£444.00	£532.80	£555.00	£666.00
1778	500	SITLAT1750	799	2726	£484.00	£580.80	£605.00	£726.00
	600	SITLAT1760	924	3153	£505.00	£606.00	£631.25	£757.50
	700	SITLAT1770	1044	3562	£534.00	£640.80	£667.50	£801.00

\*Saving based on the value of individual items when bought separately. Order any of our selected valves & matching pipe covers at the same time as your radiator; PROMOV3W (white), PROMOV3C (chrome).



**Cylinder Valve & Pipe Covers** 

**SAVE £45\***  
WHEN YOU BUY OUR CYLINDER VALVE & PIPE COVERS WITH ANY TOWEL RAIL PURCHASE. QUOTE PROMOV3 AT TIME OF ORDER.

Available in White or Chrome

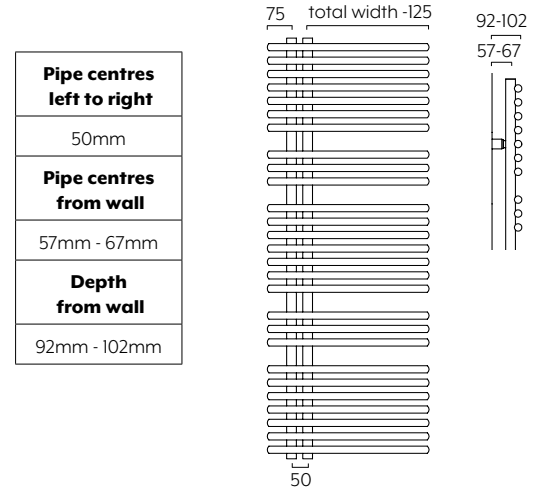

# Sitar BDO shown on page 103

High quality Italian design & manufacture  
Steel: 23mm cross tubes  
CE/UKCA approved & certified to BS EN442.

White RAL 9016 as standard, 188 RAL Colours and 30 Special Finishes  
Please call **01342 302250** for a RAL or Special Finish chart.

**Stock White RAL 9016: 48-72 Hours**  
Made to Order sizes & colours: Up to 5 weeks.

## Stock options White RAL 9016

Height (mm)	Width (mm)	Model	Watts Δt 50°C	Btu's Δt 50°C	White Ex VAT	White Inc VAT	Colours Ex VAT	Colours Inc VAT
DELIVERY TIMES					48-72 HOURS		UP TO 5 WEEKS	
373	1220	SITBDO3712	517	1764	£438.00	£525.60	£547.50	£657.00
	1520	SITBDO3715	647	2208	£527.00	£632.40	£658.75	£790.50
543	1220	SITBDO5412	776	2648	£547.00	£656.40	£683.75	£820.50
	1520	SITBDO5415	967	3299	£611.00	£733.20	£763.75	£916.50

Made to order options

Height (mm)	Width (mm)	Model	Watts Δt 50°C	Btu's Δt 50°C	White Ex VAT	White Inc VAT	Colours Ex VAT	Colours Inc VAT
DELIVERY TIMES					UP TO 5 WEEKS		UP TO 5 WEEKS	
373	520	SITBDO3752	240	819	£304.00	£364.80	£380.00	£456.00
543	520	SITBDO5452	360	1228	£351.00	£421.20	£438.75	£526.50
985	520	SITBDO9852	646	2204	£481.00	£577.20	£601.25	£721.50
	1220	SITBDO9812	1383	4719	£744.00	£892.80	£930.00	£1,116.00
	1520	SITBDO9815	1716	5855	£821.00	£985.20	£1,026.25	£1,231.50



**Cylinder Valve & Pipe Covers** 

**SAVE £45\***  
WHEN YOU BUY OUR CYLINDER VALVE & PIPE COVERS WITH ANY TOWEL RAIL PURCHASE. QUOTE PROMOV3 AT TIME OF ORDER.

Available in White or Chrome

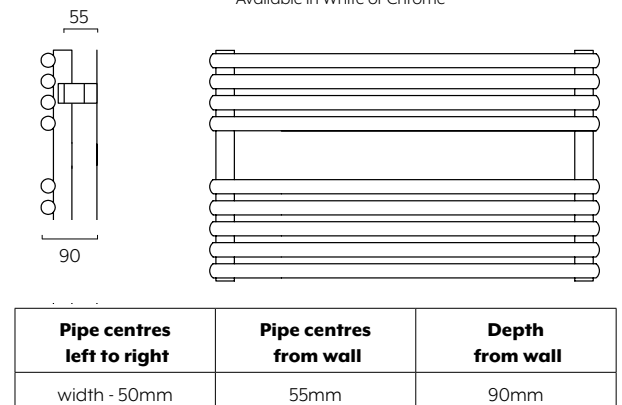

\*Saving based on the value of individual items when bought separately. Order any of our selected valves & matching pipe covers at the same time as your radiator; PROMOV3W (white), PROMOV3C (chrome).

# Poll BDO shown on page 104

Steel; 30mm square collectors, 22mm round cross tubes  
CE/UKCA approved & certified to BS EN442.

White RAL 9016 as standard, 188 RAL Colours and 30 Special Finishes  
Please call **01342 302250** for a RAL or Special Finish chart.

## Stock White RAL 9016: 48-72 Hours

Made to Order sizes & colours: Up to 7 weeks for white,  
8 weeks for colours.

Pipe centres left to right	Pipe centres from wall	Depth from wall
width - 30mm	57mm to 65mm	132mm to 140mm

## Stock options White RAL 9016

Height (mm)	Width (mm)	Model	Watts Δt 50°C	Btu's Δt 50°C	White Ex VAT	White Inc VAT	Colours Ex VAT	Colours Inc VAT
DELIVERY TIMES					48-72 HOURS		UP TO 8 WEEKS	
460	1200	POLBDO4612	574	1958	£250.00	£300.00	£312.50	£375.00
540	1200	POLBDO5412	691	2358	£282.00	£338.40	£352.50	£423.00

Made to order options - White & colours

Height (mm)	Width (mm)	Model	Watts Δt 50°C	Btu's Δt 50°C	White Ex VAT	White Inc VAT	Colours Ex VAT	Colours Inc VAT
DELIVERY TIMES					UP TO 7 WEEKS		UP TO 8 WEEKS	
460	1000	POLBDO4610	478	1631	£241.00	£289.20	£301.25	£361.50
	1400	POLBDO4614	670	2286	£262.00	£314.40	£327.50	£393.00
540	1000	POLBDO5410	576	1965	£269.00	£322.80	£336.25	£403.50
	1400	POLBDO5414	806	2750	£295.00	£354.00	£368.75	£442.50
660	1000	POLBDO6610	724	2470	£310.00	£372.00	£387.50	£465.00
	1200	POLBDO6612	869	2965	£329.00	£394.80	£411.25	£493.50
	1400	POLBDO6614	1014	3460	£344.00	£412.80	£430.00	£516.00



**Cylinder Valve & Pipe Covers**

**SAVE £45\***  
WHEN YOU BUY OUR CYLINDER VALVE & PIPE COVERS WITH ANY TOWEL RAIL PURCHASE. QUOTE PROMOV3 AT TIME OF ORDER.

Available in White or Chrome

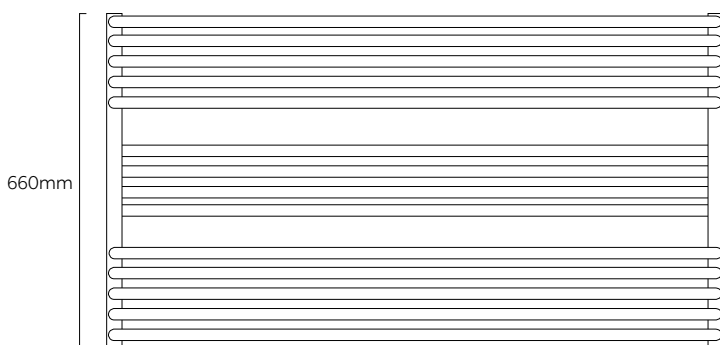
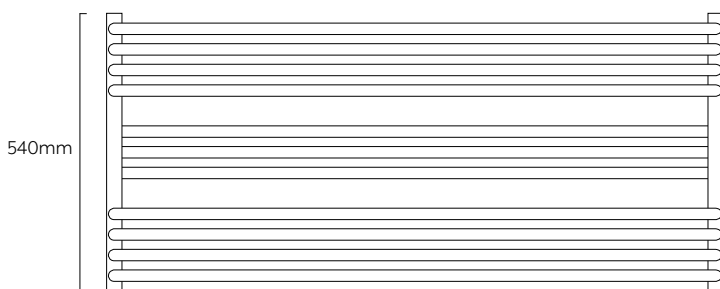
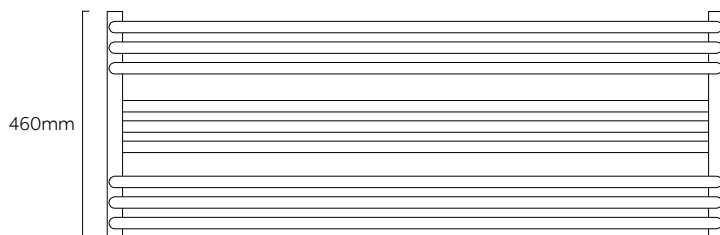
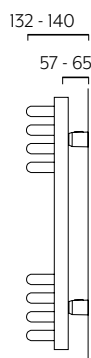

\*Saving based on the value of individual items when bought separately. Order any of our selected valves & matching pipe covers at the same time as your radiator; PROMOV3W (white), PROMOV3C (chrome).

# Poll shown on page 105

Steel; 30mm square collectors, 22mm round cross tubes  
Hydronic & Electric models  
CE/UKCA approved & certified to BS EN442.

White RAL 9016 as standard, 188 RAL Colours and 30 Special Finishes  
Please call **01342 302250** for a RAL or Special Finish chart.

### Stock White RAL 9016: 48-72 Hours

Made to Order sizes & colours: Up to 7 weeks: White Electric,  
Up to 8 weeks: Colours.



**Cylinder Valve & Pipe Covers**



**SAVE £45\***  
WHEN YOU BUY OUR CYLINDER VALVE & PIPE COVERS WITH ANY TOWEL RAIL PURCHASE. QUOTE PROMOV3 AT TIME OF ORDER.

Available in White or Chrome

Poll	Pipe centres left to right	Pipe centres from wall
Poll	width - 30mm	57mm to 65mm

### Stock options White RAL 9016

Height (mm)	Width (mm)	Model	Watts Δt 50°C	Btu's Δt 50°C	White Ex VAT	White Inc VAT	Colours Ex VAT	Colours Inc VAT
DELIVERY TIMES					48-72 HOURS		UP TO 8 WEEKS	
530	450	POLL5345	270	921	£224.00	£268.80	£280.00	£336.00
	500	POLL5350	300	1024	£230.00	£276.00	£287.50	£345.00
	600	POLL5360	360	1228	£240.00	£288.00	£300.00	£360.00
	700	POLL5370	410	1399	£245.00	£294.00	£306.25	£367.50
1055	450	POLL1045	540	1842	£285.00	£342.00	£356.25	£427.50
	500	POLL1050	604	2061	£294.00	£352.80	£367.50	£441.00
	600	POLL1060	720	2457	£312.00	£374.40	£390.00	£468.00
	700	POLL1070	850	2900	£326.00	£391.20	£407.50	£489.00
1480	500	POLL1450	857	2924	£402.00	£482.40	£502.50	£603.00
	600	POLL1460	1030	3514	£411.00	£493.20	£513.75	£616.50
	700	POLL1470	1200	4094	£429.00	£514.80	£536.25	£643.50
	800	POLL1480	1370	4674	£442.00	£530.40	£552.50	£663.00

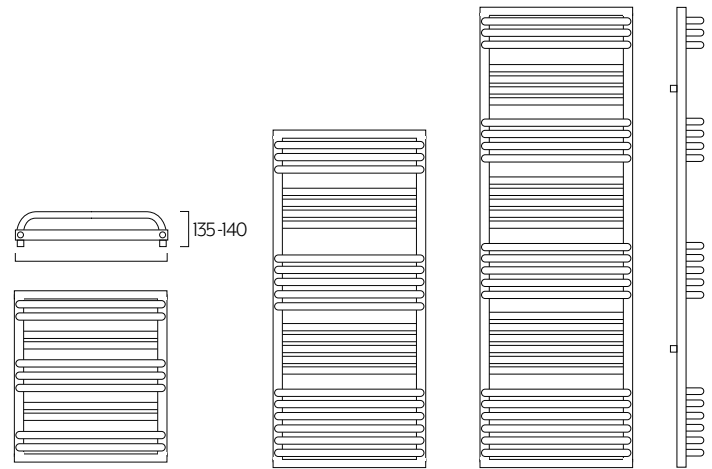

\*Saving based on the value of individual items when bought separately. Order any of our selected valves & matching pipe covers at the same time as your radiator; PROMOV3W (white), PROMOV3C (chrome).

Made to order options - White Electric

Height (mm)	Width (mm)	Model	Watts Δt 50°C	White Ex VAT	White Inc VAT
DELIVERY TIMES			UP TO 7 WEEKS		
780	500	POLL7850EW	400	£306.00	£367.20
	600	POLL7860EW	400	£325.00	£390.00
1180	500	POLL1150EW	600	£387.00	£464.40
	600	POLL1160EW	800	£414.00	£496.80
1580	500	POLL1550EW	800	£454.00	£544.80
	600	POLL1560EW	1000	£510.00	£612.00

Poll Electric models supplied with a MOA Element:

- 5 heat settings from 30°C to 60°C to regulate the internal radiator temperature. Selected setting denoted by 5 LEDs.
- No Timer.
- Compatible with external Timer as remembers settings when turned off
- 55mm diameter clock shaped face.
- 4x Buttons: Temperature +/-, Dryer, Power.
- Frost & overheating protection.
- Straight cable, no plug. IPx5. Class 1.
- Guarantee - 2 years.







# Iris shown on pages 110-111

Stainless Steel; 22mm cross tubes  
 Suitable for a direct system, Hydronic & Electric Models  
 CE/UKCA approved & certified to BS EN442.

Polished Stainless Steel.

**Stock Polished Stainless Steel: 48-72 Hours**  
 Made to Order electric: Up to 3 weeks



**Cylinder Valve & Pipe Covers**



**SAVE £45\***  
 WHEN YOU BUY OUR CYLINDER VALVE & PIPE COVERS WITH ANY TOWEL RAIL PURCHASE. QUOTE PROMOV3 AT TIME OF ORDER.

Available in White or Chrome

Pipe centres left to right	Pipe centres from wall	Depth from wall
width - 32mm	84mm	100mm

## Stock options Polished Stainless Steel - Standard

Height (mm)	Width (mm)	Model	Watts Δt 50°C	Btu's Δt 50°C	Price Ex VAT	Price Inc VAT
DELIVERY TIMES					48-72 HOURS	
800	500	IRIS8050S	198	676	£568.00	£681.60
	600	IRIS8060S	233	795	£618.00	£741.60
1200	300	IRIS1230S	217	740	£691.00	£829.20
	500	IRIS1250S	314	1071	£724.00	£868.80
	600	IRIS1260S	371	1266	£817.00	£980.40

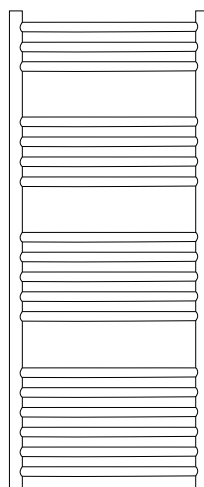

## Stock options Polished Stainless Steel - Horizontal

Height (mm)	Width (mm)	Model	Watts Δt 50°C	Btu's Δt 50°C	Price Ex VAT	Price Inc VAT
DELIVERY TIMES					48-72 HOURS	
600	1000	IRIS6010S	517	1764	£728.00	£873.60
800	1000	IRIS8010S	682	2327	£806.00	£967.20

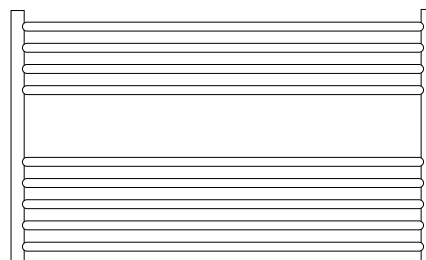

Made to order options - Standard electric

Height (mm)	Width (mm)	Model	Watts Δt 50°C	Price Ex VAT	Price Inc VAT
DELIVERY TIMES			UP TO 3 WEEKS		
800	500	IRIS8050ES	125	£788.00	£945.60
	600	IRIS8060ES	150	£838.00	£1,005.60
1200	300	IRIS1230ES	125	£911.00	£1,093.20
	500	IRIS1250ES	200	£944.00	£1,132.80
	600	IRIS1260ES	200	£1,037.00	£1,244.40

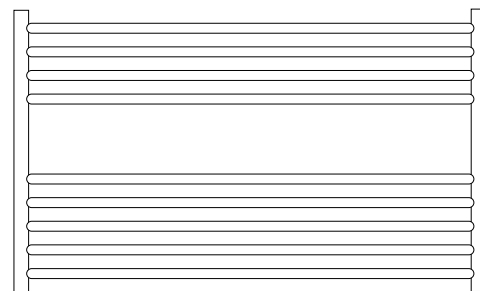
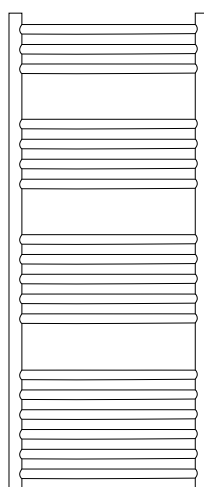

Position of element for electric models

Made to order options - Horizontal electric

Height (mm)	Width (mm)	Model	Watts Δt 50°C	Price Ex VAT	Price Inc VAT
DELIVERY TIMES			UP TO 3 WEEKS		
600	1000	IRIS6010ES	125	£948.00	£1,137.60
800	1000	IRIS8010ES	150	£1,026.00	£1,231.20

Position of element for electric models

Supplied with standard element and powered from a switched fused spur.

\*Saving based on the value of individual items when bought separately. Order any of our selected valves & matching pipe covers at the same time as your radiator; PROMOV3W (white), PROMOV3C (chrome).

# Lingfield shown on page 114

Brass tubed floor standing design, suitable for a direct system  
CE/UKCA approved & certified to BS EN442.

Chrome (main image)  
Antique Bronze  
Antique Copper  
Bright Nickel



Antique Bronze

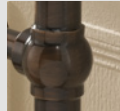

Antique Copper



Bright Nickel

## Stock Chrome: 48-72 Hours

Made to Order: Up to 10 weeks for Bright Nickel, Antique Bronze / Copper

Pipe centres left to right	Pipe centres from wall	Maximum depth from wall
width - 147mm - valves	118mm	235mm

## Stock options Chrome

Height (mm)	Width (mm)	Model	Watts Δt 50°C	Btu's Δt 50°C	Chrome Ex VAT	Chrome Inc VAT
DELIVERY TIMES					48-72 HOURS	
850	600	LING8560	439	1498	£2,817.00	£3,380.40

Made to order options

Height (mm)	Width (mm)	Model	Watts Δt 50°C	Btu's Δt 50°C	Bright Nickel Ex VAT	Bright Nickel Inc VAT	Antique Bronze Ex VAT	Antique Bronze Inc VAT	Antique Copper Ex VAT	Antique Copper Inc VAT
DELIVERY TIMES					UP TO 10 WEEKS		UP TO 10 WEEKS		UP TO 10 WEEKS	
850	600	LING8560	439	1498	£3,101.00	£3,721.20	£3,517.00	£4,220.40	£3,517.00	£4,220.40



Crosshead Valves



OUR CROSSHEAD VALVES ARE THE PERFECT MATCH FOR THESE TRADITIONAL STYLED TOWEL RAILS, SEE PAGE 125 FOR MORE INFORMATION AND PRICES.

Top view

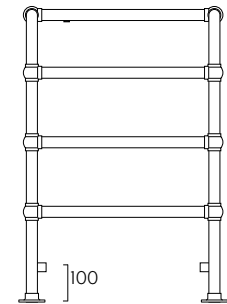
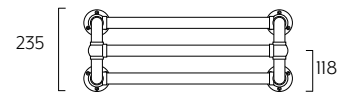

# Linton Towel Rail shown on page 115

New Colours

Steel tubes with a cast iron radiator  
CE/UKCA approved & certified to BS EN442.

Chrome steel tubes, cast iron sections available in 24 RAL colours,  
(please see page 216 for colour options)

Made to Order: Up to 7 weeks



Crosshead Valves



OUR CROSSHEAD VALVES ARE THE PERFECT MATCH FOR THESE TRADITIONAL STYLED TOWEL RAILS, SEE PAGE 125 FOR MORE INFORMATION AND PRICES.

Pipe centres left to right	Pipe centres from wall	Depth from wall
width - 122mm (+/- 2mm)- valves	140mm	315mm

Made to order options

Height (mm)	Width (mm)	Model	Watts Δt 50°C	Btu's Δt 50°C	Chrome/Colours Ex VAT	Chrome/Colours Inc VAT
DELIVERY TIMES					UP TO 7 WEEKS	
900	490	LINTR904903C	357	1218	£1,204.00	£1,444.80
	650	LINTR906505C	595	2030	£1,525.00	£1,830.00
	820	LINTR908207C	834	2846	£1,901.00	£2,281.20
1000	490	LINTR104903C	416	1419	£1,231.00	£1,477.20
	650	LINTR106505C	694	2368	£1,557.00	£1,868.40
1200	490	LINTR124903C	619	2112	£1,482.00	£1,778.40
	650	LINTR126505C	1031	3518	£1,875.00	£2,250.00

23 RAL colours are shown on page 197

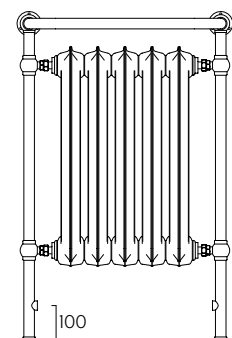
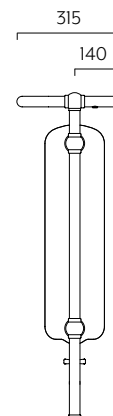

# Chalfont Floor Standing page 113

Brass tubes with a steel sectional radiator  
CE/UKCA approved & certified to BS EN442.



Chrome with White Steel Radiator (main image)  
Antique Bronze with Ivory Steel Radiator (shown below)  
Antique Copper with Ivory Steel Radiator (shown below)  
Bright Nickel with White Steel Radiator (shown below).

### Stock Chrome: 48-72 Hours.

Made to Order: Up to 10 weeks Bright Nickel & Chrome Electric,  
Antique Bronze and Antique Copper.



Pipe centres left to right	Pipe centres from wall	Maximum depth from wall
width - 157mm - valves	100mm	250mm

Crosshead Valves  OUR CROSSHEAD VALVES ARE THE PERFECT MATCH FOR THESE TRADITIONAL STYLED TOWEL RAILS, SEE PAGE 125 FOR MORE INFORMATION AND PRICES.

### Stock options Chrome

Height (mm)	Width (mm)	Model	Watts Δt 50°C	Btu's Δt 50°C	Chrome Ex VAT	Chrome Inc VAT
DELIVERY TIMES					48-72 HOURS	
938	675	CHAL9367	554	1890	£1,931.00	£2,317.20
1500	500	CHAL1550	738	2518	£2,118.00	£2,541.60

Made to order options

Height (mm)	Width (mm)	Model	Watts Δt 50°C	Btu's Δt 50°C	Bright Nickel Ex VAT	Bright Nickel Inc VAT	Antique Bronze Ex VAT	Antique Bronze Inc VAT	Antique Copper Ex VAT	Antique Copper Inc VAT
DELIVERY TIMES					UP TO 10 WEEKS		UP TO 10 WEEKS		UP TO 10 WEEKS	
938	675	CHAL9367	554	1890	£2,104.00	£2,524.80	£2,839.00	£3,406.80	£2,861.00	£3,433.20
1500	500	CHAL1550	738	2518	£2,338.00	£2,805.60	£2,901.00	£3,481.20	£2,978.00	£3,573.60

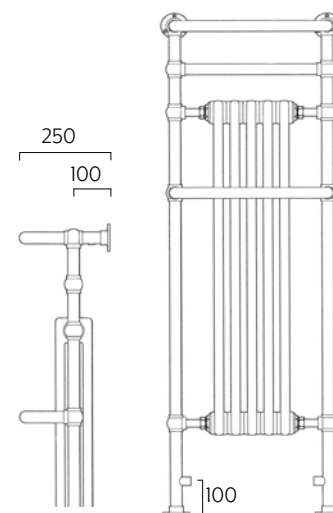

Antique Bronze



Antique Copper



Bright Nickel

Made to order options - Electric

Height (mm)	Width (mm)	Model	Watts Δt 50°C	Chrome Ex VAT	Chrome Inc VAT	
DELIVERY TIMES					UP TO 10 WEEKS	
938	675	CHAL9367EC	400	£2,206.00	£2,647.20	

Supplied with standard element and powered from a switched fused spur.

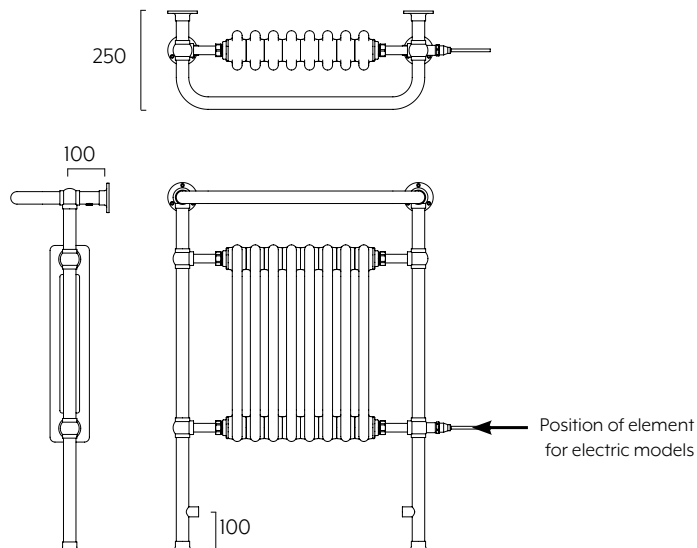

# Chalfont Wall Hung on page 113

Brass tubed wall hung design, suitable for a direct system  
CE/UKCA approved & certified to BS EN442.

Chrome (main image)  
Antique Bronze, Antique Copper & Bright Nickel (shown below).

### Stock Chrome: 48-72 Hours.

Made to Order: Up to 10 weeks Bright Nickel & Electric,  
Antique Bronze and Antique Copper.



Pipe centres left to right	Pipe centre from wall	Maximum depth from wall
width - 75mm	50mm	125mm



**OUR CROSSHEAD VALVES ARE THE PERFECT MATCH FOR THESE TRADITIONAL STYLED TOWEL RAILS, SEE PAGE 125 FOR MORE INFORMATION AND PRICES.**

### Stock options Chrome

Height (mm)	Width (mm)	Model	Watts Δt 50°C	Btu's Δt 50°C	Chrome Ex VAT	Chrome Inc VAT
DELIVERY TIMES					<b>48-72 HOURS</b>	
750	500	CHAL7550	169	577	£1,305.00	£1,566.00

Made to order options

Height (mm)	Width (mm)	Model	Watts Δt 50°C	Btu's Δt 50°C	Bright Nickel Ex VAT	Bright Nickel Inc VAT	Antique Bronze Ex VAT	Antique Bronze Inc VAT	Antique Copper Ex VAT	Antique Copper Inc VAT
DELIVERY TIMES					UP TO 10 WEEKS		UP TO 10 WEEKS		UP TO 10 WEEKS	
750	500	CHAL7550	169	577	£1,434.00	£1,720.80	£1,810.00	£2,172.00	£1,894.00	£2,272.80

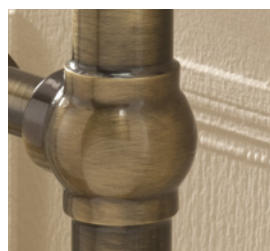
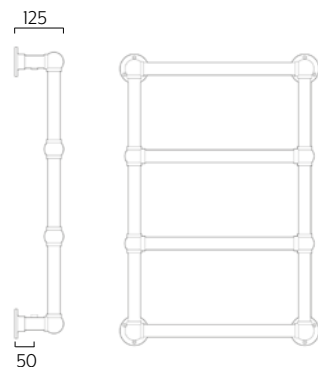

Antique Bronze



Antique Copper

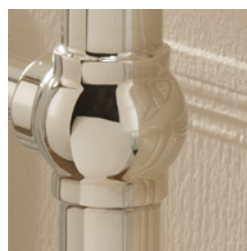

Bright Nickel

Made to order options - Electric

Height (mm)	Width (mm)	Model	Watts Δt 50°C	Chrome Ex VAT	Chrome Inc VAT	Bright Nickel Ex VAT	Bright Nickel Inc VAT
DELIVERY TIMES				UP TO 10 WEEKS		UP TO 10 WEEKS	
750	500	CHAL7550E	100	£1,580.00	£1,896.00	£1,709.00	£2,050.80

Supplied with standard element and powered from a switched fused spur.

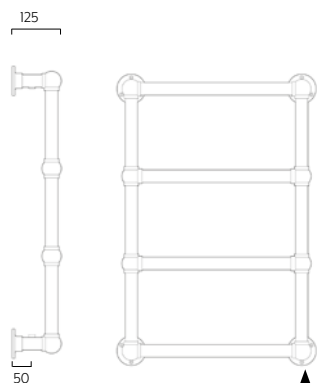

Position of element for electric models



Chalfont Electric in Chrome

# Helpful Advice

## Made to Order

We pride ourselves on having the widest range of sizes, options, colours, and accessories so that you have literally thousands of options to choose from. This means that you can have almost any radiator made to order so that it perfectly suits the space you have available, your interior design and also match your heat requirements.

## Colour Options

Many of our designs are available in a large selection of RAL colours (188 internationally recognised paint colours) and Special Finishes. If you would like a copy of our RAL or Special Finish chart please contact us on **01342 302250**. Please note that due to the printing process and manufacturing tolerances, the colour (including white) of a finished radiator may vary slightly from the colours represented in the brochure and from one colour group to another, as well as from our Special Finish & RAL charts. It should also be noted that if the same type of radiators are ordered and produced, they may also differ in finished colour from any previously ordered.

## Stock

To provide the best possible service, we hold the most popular sizes of white and chrome models in stock. So if you need quick delivery, look in the technical section for models listed with **bold** prices; these can usually be delivered within 48-72 hours.

## How much heat?

We always recommend you choose radiators with a higher output than required, as you can always turn them down & have the reassurance of additional heat in really cold spells.

## How is heat output measured?

There are two recognised measurements for heat output; BTU's (British Thermal Unit) and Watts. Within this brochure you will find both listed in the technical section by each radiator.

## Delta T's

The heat output of a radiator is established using a calculation called a delta T ( $\Delta T$ ), based on the desired room temperature of 20°C and boiler flow and return temperatures; European standards use delta T50°C as a measurement, this is based on a boiler flow temperature of 80°C and a return of 60°C ( $80^\circ\text{C} + 60^\circ\text{C} \div 2 - 20^\circ\text{C} = 50^\circ\text{C}$ ). Some systems using renewable energy sources may have different flow and returns and therefore different delta T's (e.g.  $60^\circ\text{C}/40^\circ\text{C} = \text{delta T}30^\circ\text{C}$ ). If you require outputs based on alternative delta's please contact us on **01342 302250**.

## BS EN442

Our radiators are produced & outputs measured according to BS EN442. This standard uses delta T50 to provide a consistent and comparative output measurement. Some installers may still use the old delta T60 as a measure of output, to convert use the following correction factors;  $\Delta T50$  to  $\Delta T60$  multiply by 1.267,  $\Delta T60$  to  $\Delta T50$  multiply by 0.781.

## How can I find out what heat outputs I need?

Your installer should be able to confirm the exact requirements for each of your rooms, but you can also visit our website ([theradiatorcompany.co.uk](http://theradiatorcompany.co.uk)) and use our online heat calculator or use the following simple calculation as a guide;

1. Find the volume of your room in cubic feet = height x width x length (To convert cubic metres into cubic feet multiply the total figure by 35.31).
2. Multiply the volume by 6 to find the BTU requirement. If you need to know the Watts equivalent, divide your BTU by 3.412.

For example:

A bathroom 6'x8' with 8' ceilings = a volume of 384 cubic feet multiply by 6 = 2304 Btu's

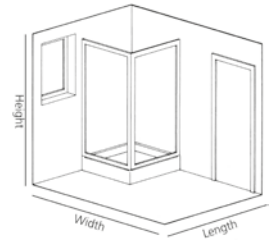

You may need more than 1 radiator in order to ensure an even distribution of heat in a large room, if so divide the required output by the total number of radiators you could sensibly place in the room.

e.g. a lounge 14' x 18' x 8' ceilings = 12096 Btu's.

Two radiators would require an output of = 6048 BTU's each,  
3 radiators = 4032 BTU's each

## Do different designs affect output?

By altering the size, shape or number of tubes or columns in a radiator you can adjust the output achieved, as this adds or subtracts surface area, the main contributor to heat output. For example, the multiple columns of our Ancona® range provide huge flexibility in achieving the right output in a limited space.



## Single or double radiators

Using models with additional rows of tubes or multiple columns maximises heat output within the same wall space.

Our Water Lily design comes in single or double versions, as an example of comparative heat outputs:

*Water Lily single 2020mm x 312mm = 2238 BTU's*

*Water Lily double 2020mm x 312mm = 3180 BTU's*



## Horizontal or Vertical;

Many of our designs are available in horizontal or vertical options which means you can maximise the use of ceiling heights and long low spaces, without losing output.

# How to order

## Order your radiator in seven easy steps

- 1. Confirm your heat output requirements for the room where you need the radiator or towel rail;** this ensures the radiators you choose will deliver the heat output you need. Use the BTU (heat output calculator) on our website [theradiatorcompany.co.uk](http://theradiatorcompany.co.uk) then decide how many radiators you need for the relevant room; discuss this and positions with your installer if needed.
- 2. Choose your design;** our range has everything from traditional cast iron to modern feature radiators, even an environmentally friendly aluminium range, with an extensive choice of sizes, colours & outputs.
- 3. Select a size that matches the heat output requirement;** outputs are shown in our technical section & will help you & your installer to find the best match for your needs.
- 4. Choose the colour you want;** with over 200 colours & special finishes you are able to match your colour scheme or introduce an accent colour to create a striking feature.
- 5. Find a valve to complete the look;** Choose from our wide selection of valves and add any accessories that complement your choice.
- 6. Order from your nearest showroom or merchant** to find your nearest branch call us on **01342 302250** or visit [theradiatorcompany.co.uk](http://theradiatorcompany.co.uk)
- 7. Order online from our website [theradiatorcompany.co.uk](http://theradiatorcompany.co.uk)**

*For help in choosing a sectional radiator (modular radiators that can be built by section to achieve a size and/or output requirement), please visit our website to use one of our online radiator builders for Ancona® Steel Multi Column, Cast Iron and Sectional Aluminium.*

## Our Product Range

- All our radiators are produced and outputs measured in accordance with BS EN442 and as such are CE/UKCA approved.
- Radiators are supplied with BOE connections as standard unless otherwise stated. B2 underneath connections can be supplied with selected models. Full technical details can be found from **pages 128 to 213** and all details are in accordance with our factory or manufacturing partner's terms of reference at the time of going to print.
- Due to the excessively corrosive nature of chlorine, we do not recommend that radiators & towel rails are placed in swimming pool environments. In addition, radiators should not be located in areas that have long term exposure to high levels of moisture without suitable ventilation.
- When commissioning any radiator (including aluminium) on an indirect/closed system, we recommend using a suitable mixed metal inhibitor in suitable quantities to protect against scale & corrosion. We can provide the water content of our radiators if required to help the installer calculate this if needed.

## Electric / Dual Fuel

Selected towel rails can be converted to work as dual fuel models. An element and T-piece are needed to adapt the towel rail; your installer will need to be aware if you wish to do this in order to adjust pipe centres accordingly. **See pages 116 - 117** for our range of elements. If a towel rail is suitable for dual fuel, it will be noted on the product technical page.

## Pipe Centres

We endeavour to ensure all pipe centres are correct, however manufacturing tolerances must be considered. Therefore we strongly recommend that pipe work is not altered or adjusted until your new radiator or towel rail is delivered. The Radiator Company will not accept any responsibility for claims resulting from incorrect pipe centres.

## Delta T's

The heat output of a radiator is established using a calculation called a delta T ( $\Delta T$ ), based on a desired room temperature of 20°C and boiler flow & return temperatures; European standards use delta T50°C as a measurement, this is based on a boiler flow temperature of 80°C and a return of 60°C ( $80^\circ\text{C} + 60^\circ\text{C} \div 2 - 20^\circ\text{C} = 50^\circ\text{C}$ ). Some systems using renewable energy sources may have different flow and returns and therefore different delta T's (e.g  $60^\circ\text{C}/40^\circ\text{C} = \text{delta T}30^\circ\text{C}$ ). If you require outputs based on alternative delta's please contact us on **01342 302250**.

## Delivery

Please note that many of our factories close for 2-4 weeks during the holiday periods of July/August and December. This may extend the delivery period quoted for non stock made to order items ordered during July/August & December/January. We will confirm the expected delivery date on our order acknowledgement at the time of order. Unfortunately, delivery to Scotland / Offshore Islands may take longer due to the distances involved. Deliveries will be made to the nearest hard standing area.

## Systems

All radiators and towel rails featured in this brochure are suitable for indirect/closed systems that comply with 'BS5449, section 1 forced circulation hot water systems'. Systems running with low pressures (under 1 Bar), microbore pipework or modern boilers with modulating pumps, may experience flow and heating issues if not accounted for in the system design which could result in radiators not heating fully or noisy pipework.

Direct heating systems use your hot water supply to heat a radiator; usually this will occur in a bathroom. If you have any radiators or towel rails linked to a direct system they should be made from either stainless steel or brass to avoid rusting and contaminating the hot water supply. However it should be noted that these radiators are not suitable for Direct systems fitted with a water softener.

## Powder coat finishes and Painted cast iron

It should be noted that due to the production process colours can vary by +/- 5 to 10% from samples provided and between radiators ordered in the same colour at different times.

All painted cast iron radiators will be checked and tested prior to despatch. Care must be taken when handling and joining painted cast iron radiators on-site to avoid damaging the finish. Cast iron radiators will be supplied with a small bottle of touch up paint in case of damage to the finish during installation, however, it should be noted that this may vary slightly from the standard powder coat finish. As a result of the casting process, cast iron radiators have a rough surface finish with small imperfections which will show after the painting process.

## Terms & Conditions

For a copy of The Radiator Company full Terms & Conditions please call our Customer Services department on **01342 302250** or visit [theradiatorcompany.co.uk](http://theradiatorcompany.co.uk)

# 23 RAL Colours

For Sectional Aluminium, Cast Iron, Torr , Canto, Iseo, Niro, Poppy & Lupin ranges

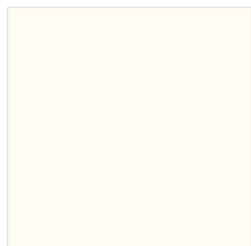

RAL 9010 - Pure white

Supplied as standard for Aluminium (Vip, Oscar, Mix & Vox)

Optional RAL Colour for all Cast Iron including the Linton Towel Rail, plus the Torr , Canto, Iseo, Niro and Poppy & Lupin ranges.



RAL 1001 - Beige

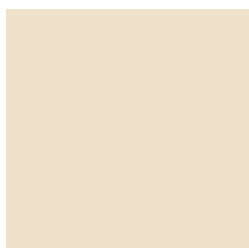

RAL 1013 - Oyster white



RAL 1015 - Light ivory



RAL 1019 - Grey beige



RAL 3000 - Flame red



RAL 3003 - Ruby red



RAL 3004 - Purple red



RAL 4003 - Heather violet



RAL 5024 - Pastel blue



RAL 6006 - Grey olive



RAL 6013 - Reed green



RAL 7016 - Anthracite grey



RAL 7032 - Pebble grey

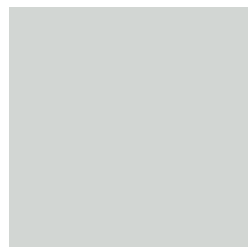

RAL 7035 - Light grey



RAL 7040 - Window grey



RAL 7042 - Traffic grey A

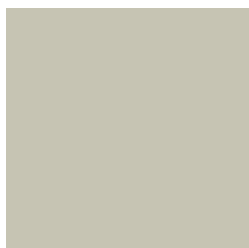

RAL 7044 - Silk grey



RAL 8011 - Nut brown



RAL 8025 - Pale brown

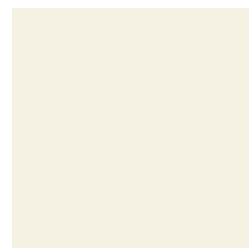

RAL 9001 - Cream

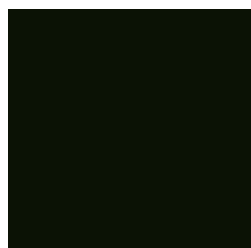

RAL 9004 - Signal black

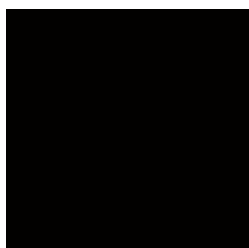

RAL 9005 - Jet black

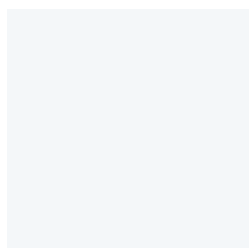

RAL 9016 - Traffic white

**Please Note:**

Due to printing processes and manufacturing tolerances, the colour of finished radiators may vary slightly from those colours shown on this page.

Please call **01342 302250** for a RAL chart.



# Colour Coordination

We understand that many interior designs can be enhanced with carefully applied colour coordination or contrasts to create a standout feature. Today we have a huge choice of brands and exciting colour palettes and tones to choose from for our walls and woodwork, providing the opportunity to create truly stunning rooms. If you are looking to create a uniquely personal look using colours from either popular or premium paint brands, we can take your chosen colour and create a highly durable powder coat finish that will allow your radiator to blend in with your wall colour, or stand out if you want to make a statement!

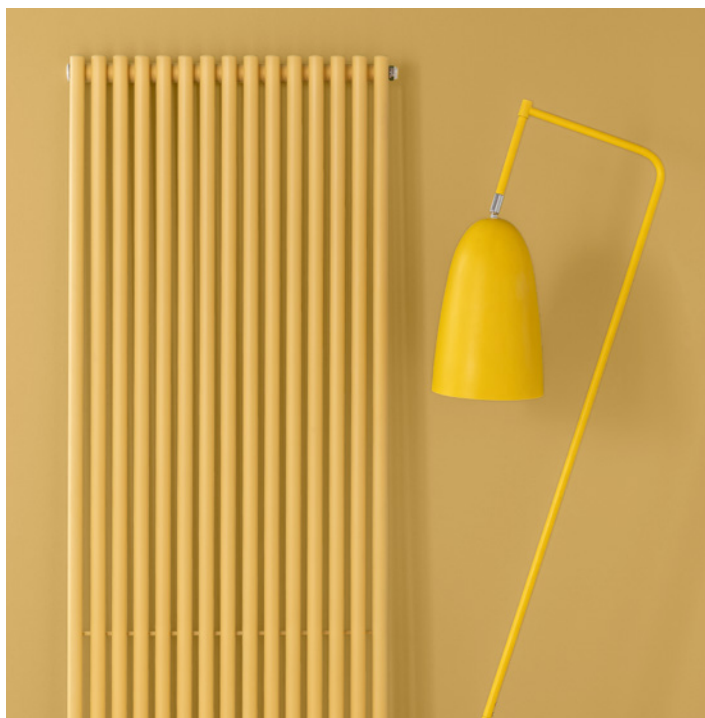

Sitar radiator colour coordinated to Farrow & Ball® paint Citron 74

Making sure that you get something that reflects the effort you have taken in choosing your colours is important. Once we know the radiators you are interested in and the make, name and code of your chosen colour, we can supply a quote and an estimate of delivery times. **Please note that sometimes we will require a physical sample to colour match from.**

The first step is to order a colour sample, for which a small charge of £120 Inc VAT will apply (this will be deducted from the full order when placed). We will then mix a batch of powder and prepare a sample for you to check and approve. Once you are happy, you can proceed to order your radiators.

To achieve your desired colour and allow for the sample and final production, we have an extension on our standard delivery times to allow for the process, this could be up to 6 weeks for the sample, and once the sample has been approved, up to 8 weeks for the completion of your radiator order. Timescales will be determined by the size and quantity of radiators you require, we will be able to provide a more accurate estimation when we quote for your project.

The colour coordination icon indicates which products are available for this service and are shown on the relevant technical pages. Please call us on **01342 302250** or visit **theradiatorcompany.co.uk** for more information.



® Registered trademark of Farrow & Ball Holdings Limited



Ledbury radiator colour coordinated to Benjamin Moore paint Van Deusen Blue (HC-156)



Ancona radiator with matching Pistol TRV's, pipe covers and shrouds colour coordinated to Benjamin Moore paint Aegean Teal (2136-40)

# Index

<b>A</b>	<b>Pages</b>
Aluminium Accessories	175
Aluminium, Sectional	64-71, 174-183
Ancona®	8-29, 128-147
Ancona® Bare Metal Lacquer	16-17, 136-137
Ancona® Bench seat	26-27, 144-145
Ancona® Curved	28, 146
Ancona® Electric	29, 147
Ancona® Made To order	18-25, 138-143
Ancona® Stock	8-11, 128-135
Ancona® Feature Finishes	12-13, 128-135
Aston	76-77, 185
Athena	56-57, 170
Athena, BDO	92, 195
Athena Towel Rail	93, 195
<b>B</b>	
BDO Athena	92, 195
BDO Poll	104, 206
BDO Sitar	103, 205
BDO Step	90, 196
Black & Brass TRV	124
Blues	112, 203
Bohemia	86-87, 194
<b>C</b>	
Ceramica Collection	32-33, 148
Canto	44, 154
Cast Iron Radiators	72-87, 184-194
Chalfont	113, 212-213
Chalfont Electric	113, 212-213
Colour coordination	217
Crosshead Valve	125
Cylinder Valve	125
<b>D</b>	
Designer Radiators	30-61, 48-173
Dual Fuel Elements & Valve	116-117
<b>E</b>	
Echo	95, 199
Echo Electric	95, 199
Electric Elements	116-117
Ellipsis	45-47, 155-159
Ellipsis Stainless Steel	45, 155
Ellipsis Towel Rail	101, 204
End panels (Vip, Oscar)	176-179

<b>F</b>	<b>Pages</b>
Feature Finishes	14
<b>G</b>	
Griffin	99, 202
Griffin Electric	99, 202
<b>H</b>	
Halo	60-61, 171
<b>I</b>	
Immagina	55, 169
Ideal Corner TRV	120
Ideal TRV	121
Iris	110-111, 210
Iris Electric	110-111, 210
Iseo	38-39, 151
<b>L</b>	
Ledbury	74-75, 186-187
Lingfield	114, 211
Linton	82-83, 190-191
Linton Towel Rail	115, 211
Lupin	108-109, 209
Lupin Electric	108-109, 209
<b>M</b>	
Mini Cube Valve	125
Mix	70-71, 182-183
<b>N</b>	
Niro	36-37, 150
<b>O</b>	
Odolo	42-43, 153
Oscar	66-67, 178-179
<b>P</b>	
Painted Valves	119
Piano	52-53, 166-167
Piano Lato	97, 199
Piano Towel Rail	96, 200
Pipe Covers	119, 126
Pistol TRV	119, 124
Poll	105, 207
Poll Electric	105, 207
Poll, BDO	104, 206
Poppy	106-107, 208
Poppy Electric	106-107, 208
Pulsar	100, 203

<b>Q</b>	<b>Pages</b>
Quadre	98, 201
<b>R</b>	
Relax	58-59, 172-173
Relax Bagno	94, 198
<b>S</b>	
Sax	50-51, 164-165
Sebino	40-41, 152
Sectional Aluminium	64-71, 174-183
Shrouds	119, 126
Sitar	48-49, 160-163
Sitar Lato	102, 205
Sitar, BDO	103, 205
Stamford	78-79, 192
Steel Multi Column	6-29, 128-147
Step	91, 197
Step Electric	91, 197
Step, BDO	90, 196
Standard wall brackets	129/131/142
<b>T</b>	
Tinted Laquers	15
Telford	80-81, 188-189
Torrè	34-35, 149
Towel Rail Section	88-115, 195-213
T-Pieces	117
Trieste	84-85, 193
<b>V</b>	
Valve Section	118-125
Vintage TRV	122
Vintage XL TRV	123
Vip	64-65, 176-177
Vox	68-69, 180-181
<b>W</b>	
Water Lily	54, 168
3 Style valve	125

## Convactor Radiators

Our convactor ranges, Trench and Mini, are still available to order. Full details can be found on our website, [theradiatorcompany.co.uk](http://theradiatorcompany.co.uk).





Design | Choice | Service

[theradiatorcompany.co.uk](http://theradiatorcompany.co.uk)

Tel. 01342 302250 Fax. 01342 302260 [sales@theradiatorcompany.co.uk](mailto:sales@theradiatorcompany.co.uk)